

MOTOPLASTIC, S.A.

Molí de la sal, 1 - 08403 Granollers (Barcelona) SPAIN

Tel. 34 93 849 06 33 - Fax 34 93 849 09 88

info@puig.tv - info@puigusa.com

www.puig.tv - www.puigusa.com

Ref.: 7004

INSTRUCCIONES DE MONTAJE - MOUNTING INSTRUCTIONS - MONTAGEANLEITUNG







CÚPULA ADAPTABLE A - SCREEN FOR - WINDSCHUTZSCHEIBE FÜR KTM RC 125/200/390

SIN CÚPULA ORIGINAL / WITHOUT ORIGINAL SCREEN

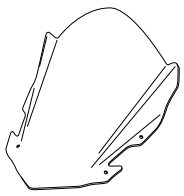

CON CÚPULA ORIGINAL / WITH ORIGINAL SCREEN



ID.	PIEZA / PART	DESCRIPCIÓN	DESCRIPTION	QTY.
1		Cúpula	Screen	1
2		Tornillo especial M6x13 con hexagonal 18mm y rosca int. M5x11	Special Screw M6x13 with hexagonal 18mm and interior thread M5x11	2
3		Tornillo especial M6x13 con hexagonal 14mm y rosca int. M5x11	Special Screw M6x13 with hexagonal 14mm and interior thread M5x11	2
4		Arandela de goma Ø ext. 15 Ø int. 5x4	Ø outer 15 x Ø inner 5x4 rubber washer	4
5		Tornillo Allen M5x16 ISO 7380 (negro)	M5x16 ISO 7380 (black) Allen screw	4
6		Arandela nylon M5x0,5	M5x0,5 nylon washer	4

MOTOPLASTIC, S.A.

Molí de la sal, 1 - 08403 Granollers (Barcelona) SPAIN

Tel. 34 93 849 06 33 - Fax 34 93 849 09 88

info@puig.tv - info@puigusa.com

www.puig.tv - www.puigusa.com

INSTRUCCIONES DE MONTAJE - MOUNTING INSTRUCTIONS - MONTAGEANLEITUNG

CÚPULA ADAPTABLE A - SCREEN FOR - WINDSCHUTZSCHEIBE FÜR KTM RC 125/200/390

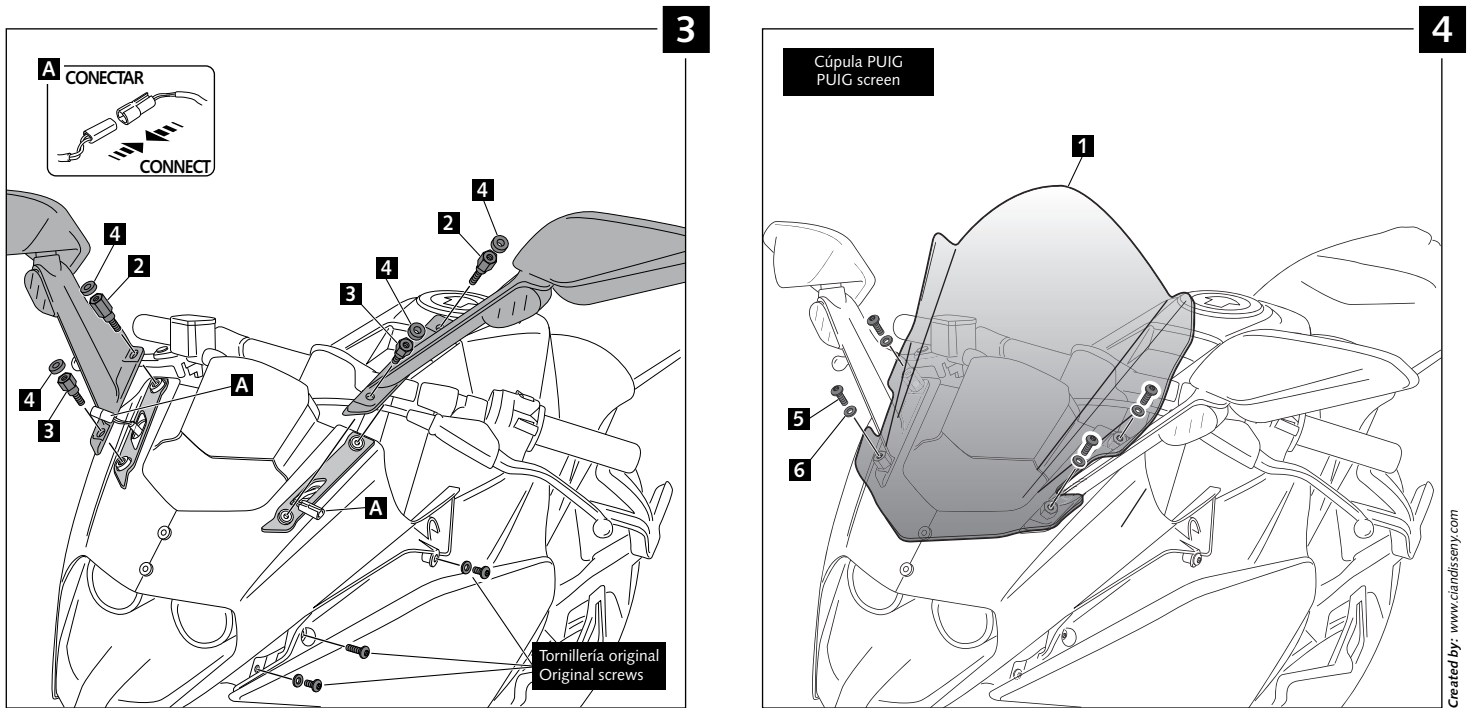
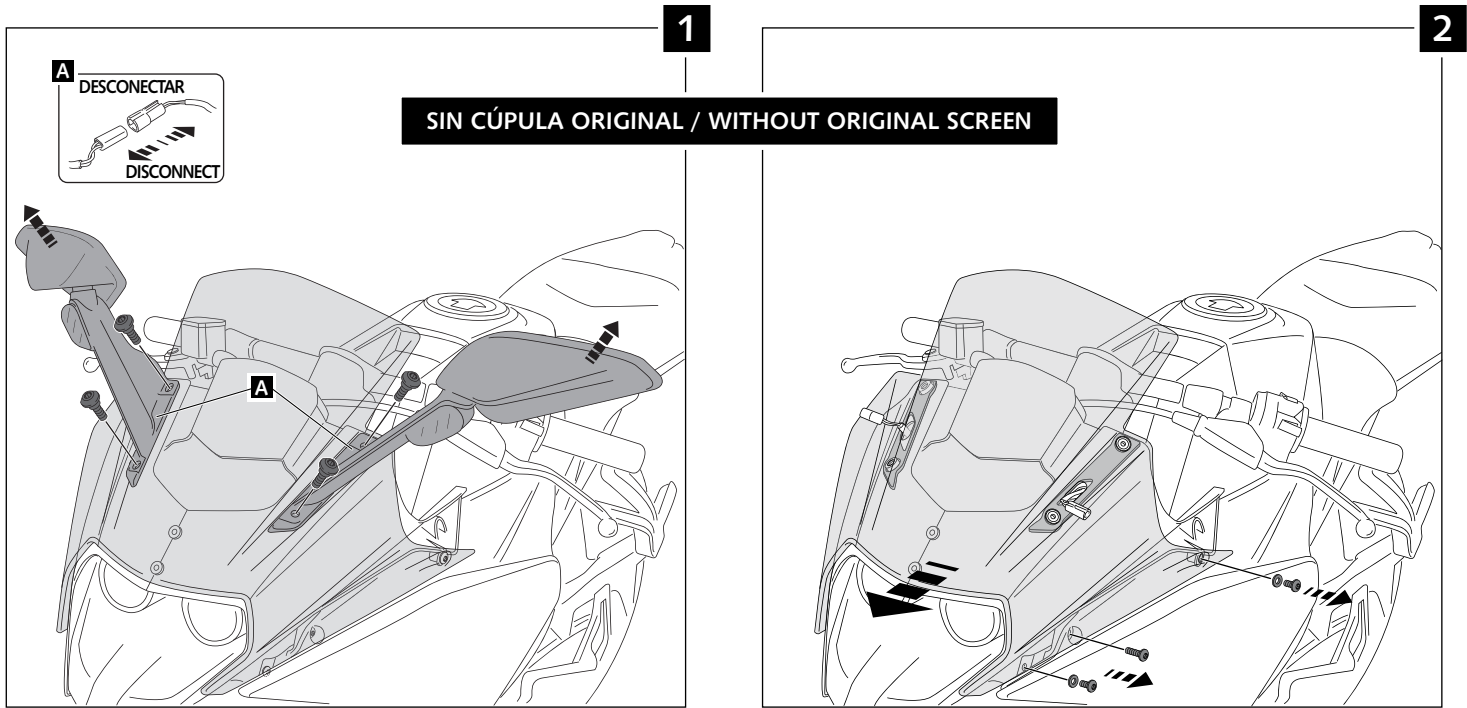

MOTOPLASTIC, S.A.

Molí de la sal, 1 - 08403 Granollers (Barcelona) SPAIN

Tel. 34 93 849 06 33 - Fax 34 93 849 09 88

info@puig.tv - info@puigusa.com

www.puig.tv - www.puigusa.com

INSTRUCCIONES DE MONTAJE - MOUNTING INSTRUCTIONS - MONTAGEANLEITUNG

CÚPULA ADAPTABLE A - SCREEN FOR - WINDSCHUTZSCHEIBE FÜR KTM RC 125/200/390

1

CON CÚPULA ORIGINAL / WITH ORIGINAL SCREEN

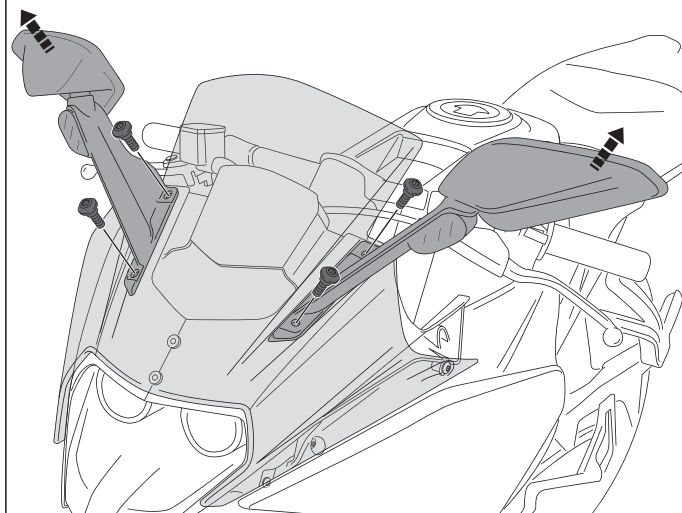

2

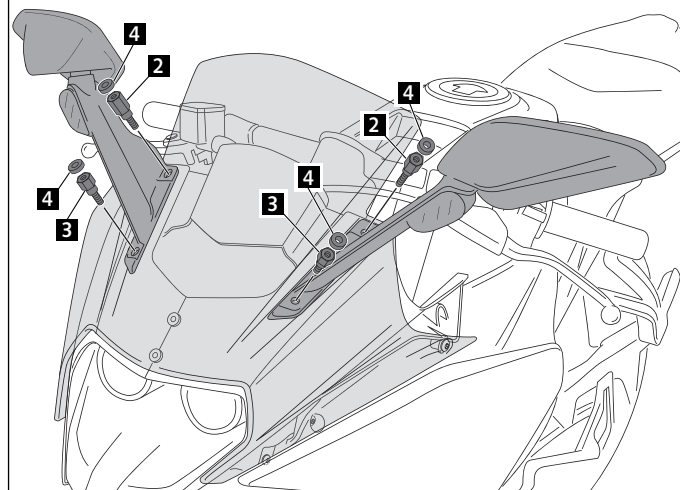

3

Cúpula PUIG
PUIG screen

