

MOTOPLASTIC, S.A.

Molí de la sal, 1 - 08403 Granollers (Barcelona) SPAIN

Tel. 34 93 849 06 33 - Fax 34 93 849 09 88

info@puig.tv - info@puigusa.com

www.puig.tv - www.puigusa.com

Ref.: 7640
(Mod. TOURING)

Ref.: 7639
(Mod. SPORT)

INSTRUCCIONES DE MONTAJE - MOUNTING INSTRUCTIONS - MONTAGEANLEITUNG







CÚPULA ADAPTABLE A - SCREEN FOR - WINDSCHUTZSCHEIBE FÜR SUZUKI GSX-S1000F '15-'19

Mod. TOURING

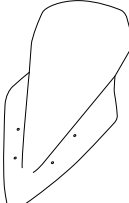

Mod. SPORT



| ID. | PIEZA / PART | DESCRIPCIÓN | DESCRIPTION | QTY. |
|-----|---|--|---|------|
| 1 |  | Cúpula TOURING (ref. 7640) | TOURING screen (ref. 7640) | 1 |
| |  | Cúpula SPORT (ref. 7639) | SPORT screen (ref. 7639) | |
| 2 |  | Tornillo especial M5x20+rosca interior M5x15 | Special screw M5x20+interior thread M5x15 | 2 |
| 3 |  | Tornillo especial M5x13+rosca interior M5x8 | Special screw M5x13+interior thread M5x8 | 2 |
| 4 |  | Arandela de goma M5x4 | M5x4 rubber washer | 4 |
| 5 |  | Silentblock M5 | M5 silentblock | 4 |
| 6 |  | Tornillo Allen M5x16 ISO 7380 (negro) | M5x16 ISO 7380 Allen screw (black) | 4 |
| 7 |  | Arandela de nylon M5x0,5 | M5x0,5 nylon washer | 4 |
| 8 |  | Tapón tornillo M5 ISO 7380 | M5 ISO 7380 Screw cap | 4 |

MOTOPLASTIC, S.A.

Molí de la sal, 1 - 08403 Granollers (Barcelona) SPAIN

Tel. 34 93 849 06 33 - Fax 34 93 849 09 88

info@puig.tv - info@puigusa.com

www.puig.tv - www.puigusa.com

INSTRUCCIONES DE MONTAJE - MOUNTING INSTRUCTIONS - MONTAGEANLEITUNG

CÚPULA ADAPTABLE A - SCREEN FOR - WINDSCHUTZSCHEIBE FÜR SUZUKI GSX-S1000F '15-'19

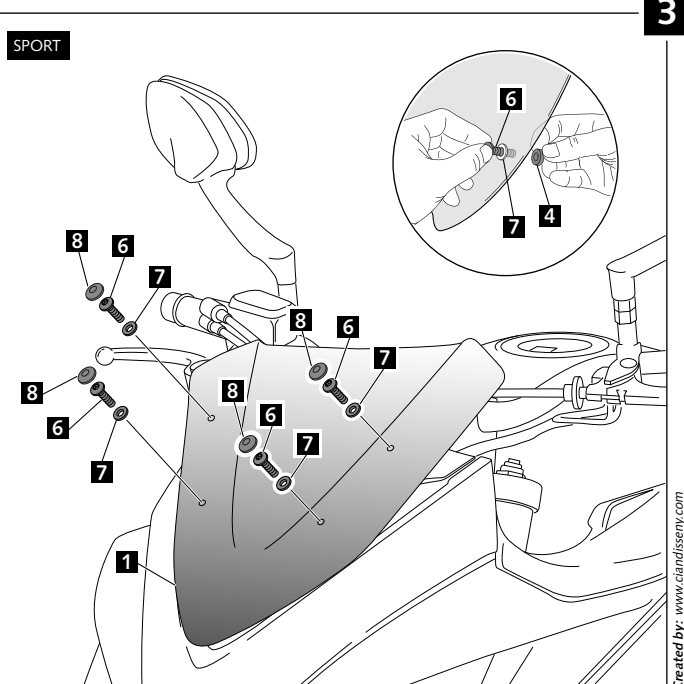
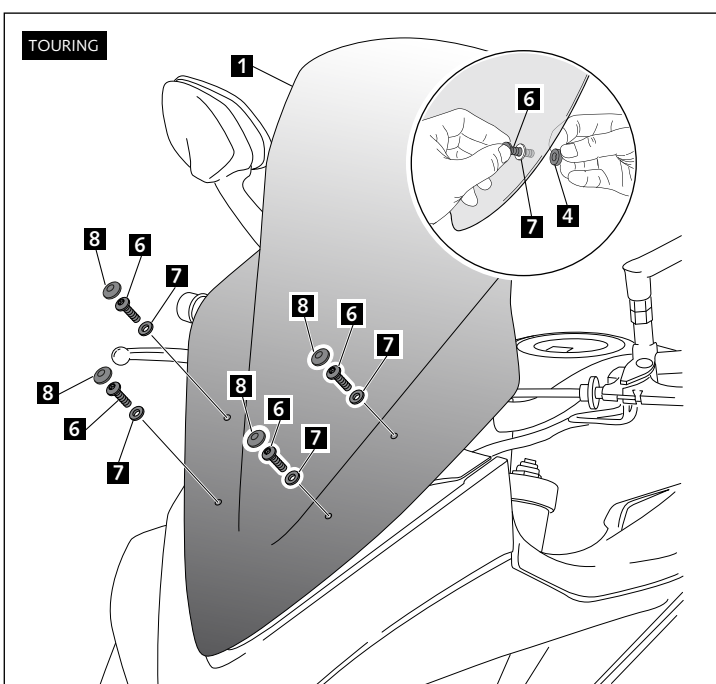
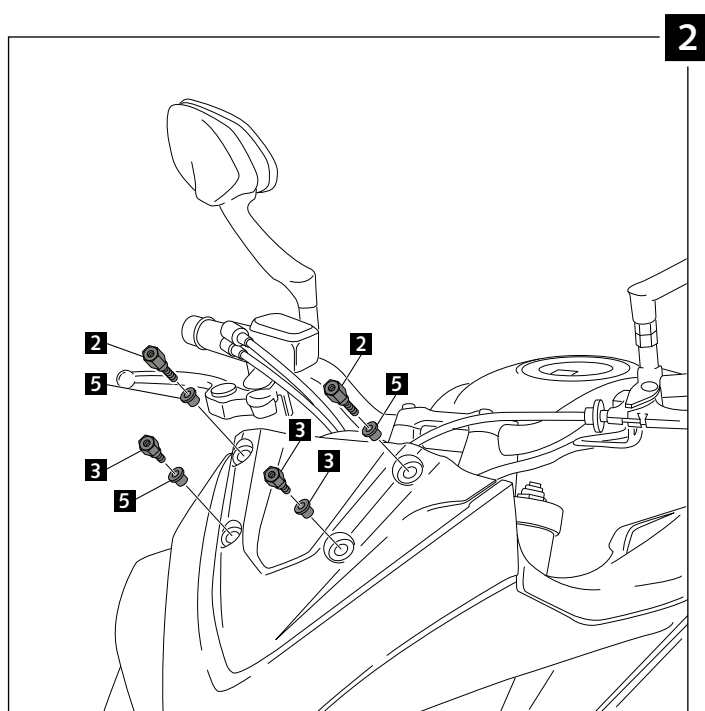
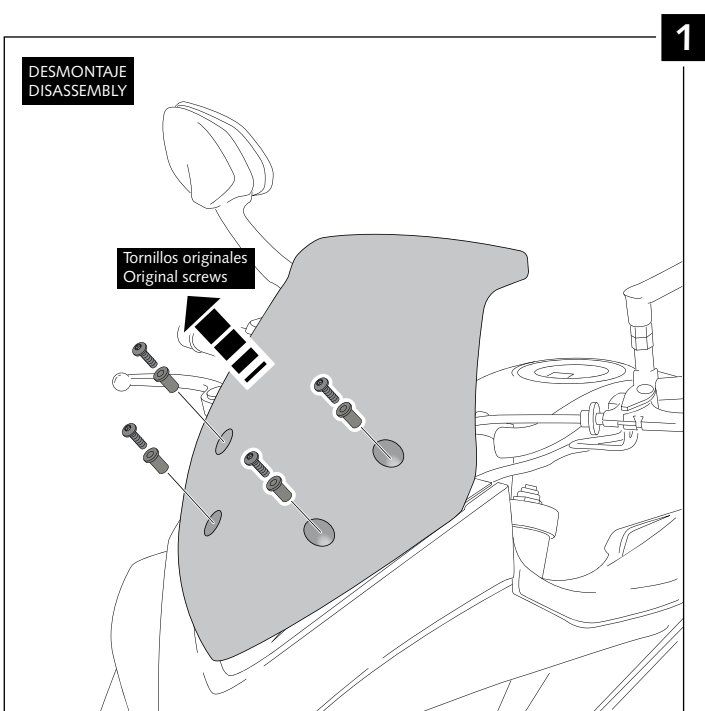

VISERA MULTIREGULABLE MULTI-ADJUSTABLE VISOR

CÚPULA TIPO
TYPE WINDSCREEN **A**



CÚPULA TIPO
TYPE WINDSCREEN **B**



CÚPULA TIPO
TYPE WINDSCREEN **C**



Ref.: 6007

Ref.: 5852

Ref.: 5853

Ahumado/Smoke

Transparente/Clear

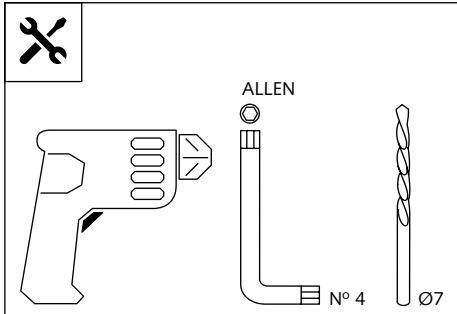

1 persona
1 person



15 min

Fácil - Easy

Media-Intermediate

Difícil-Difficult

Nota/Note:

Si la visera se suministra con la cúpula Puig, no será necesario realizar los agujeros por que ya vienen incorporados.

If the visor is supplied along with the windscreen, the windscreen will come factory-drilled so no drilling is necessary.

| ID. | PIEZA / PART | DESCRIPCIÓN | DESCRIPTION | QTY. |
|-----|--------------|-------------------------------|-------------------------------|------|
| 1 | | Visera | Visor | 1 |
| 2 | | Plantilla | Template | 1 |
| 3 | | Mecanismo multiregulable | Multi-adjustable mechanism | 2 |
| 4 | | Tapeta | Cap | 4 |
| 5 | | Tornillo rosca plástico M6x12 | Plastic thread fastener M6x12 | 8 |

VISERA MULTIREGULABLE MULTI-ADJUSTABLE VISOR

INSTRUCCIONES DE MONTAJE - MOUNTING INSTRUCTIONS - MONTAGEANLEITUNG

TIPO/TYPER A - TIPO/TYPER A - TIPO/TYPER A

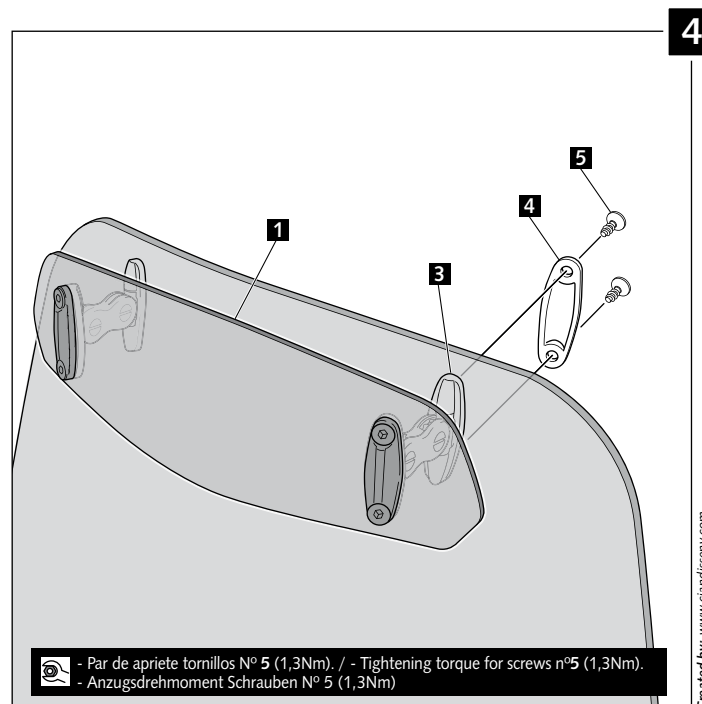
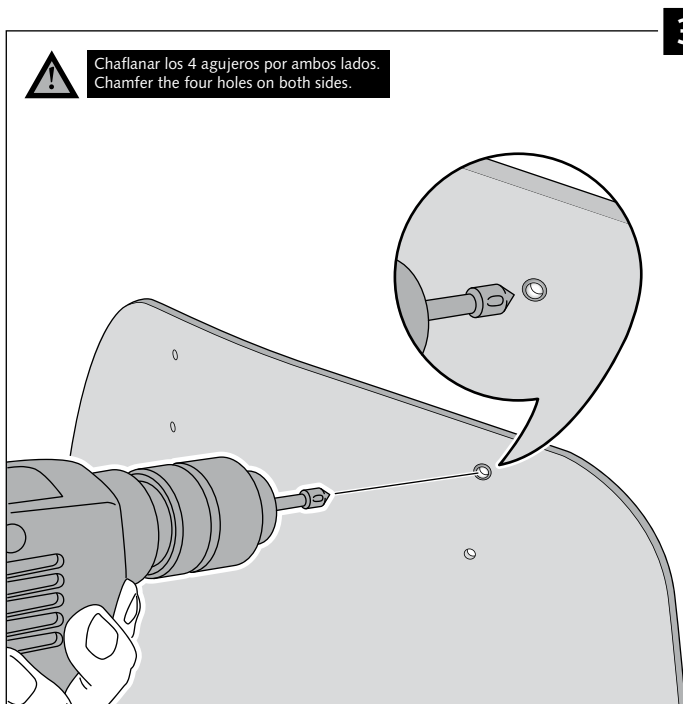
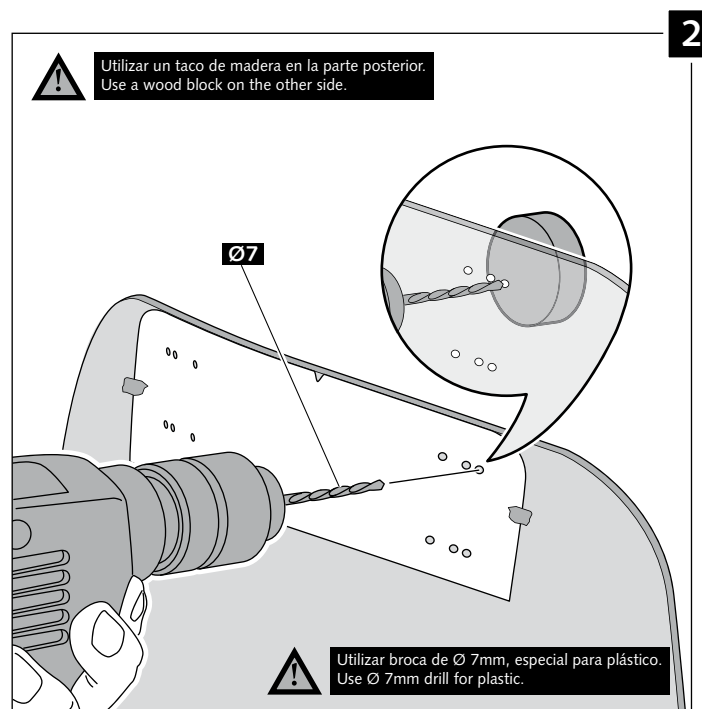
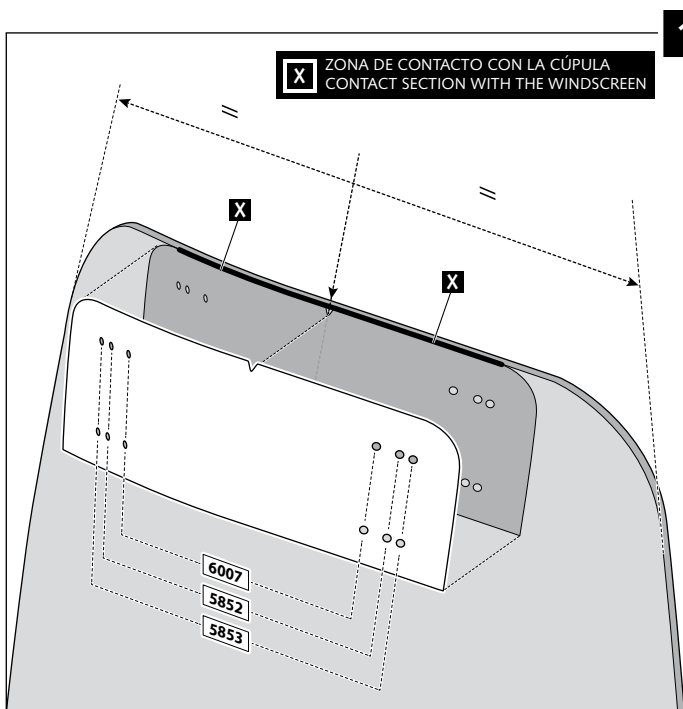

VISERA MULTIREGULABLE MULTI-ADJUSTABLE VISOR

INSTRUCCIONES DE MONTAJE - MOUNTING INSTRUCTIONS - MONTAGEANLEITUNG

TIPO/TYPE B - TIPO/TYPE B - TIPO/TYPE B

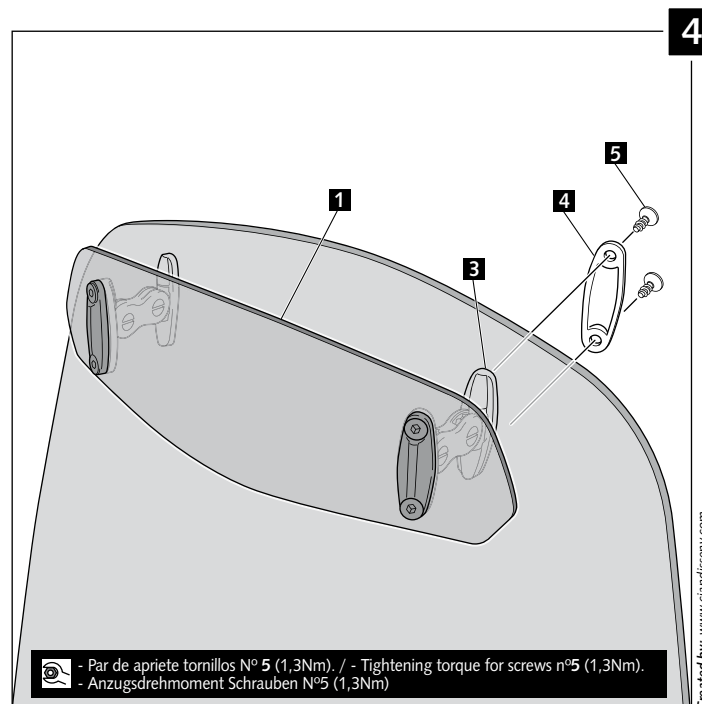
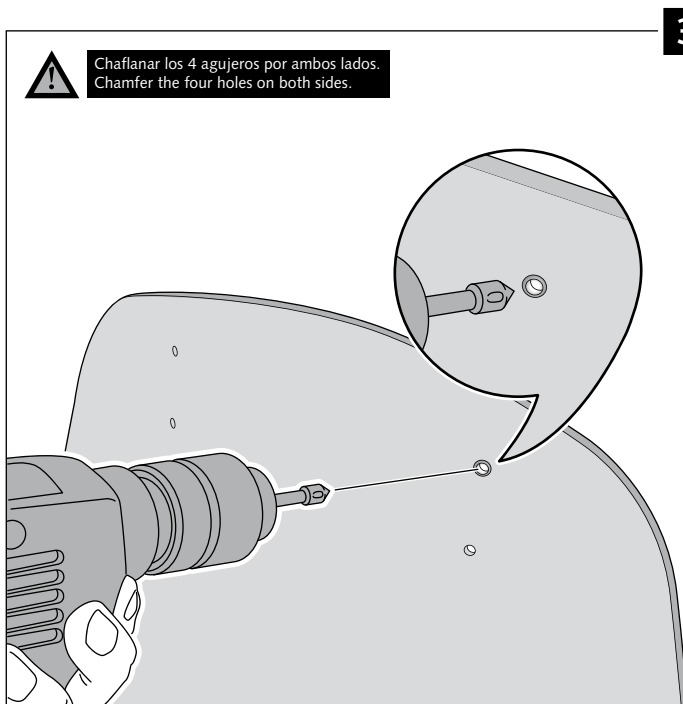
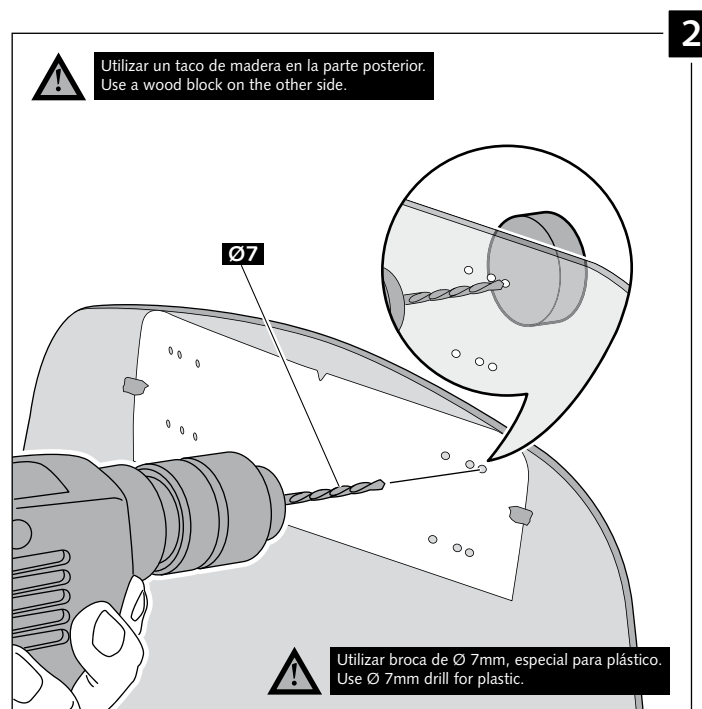
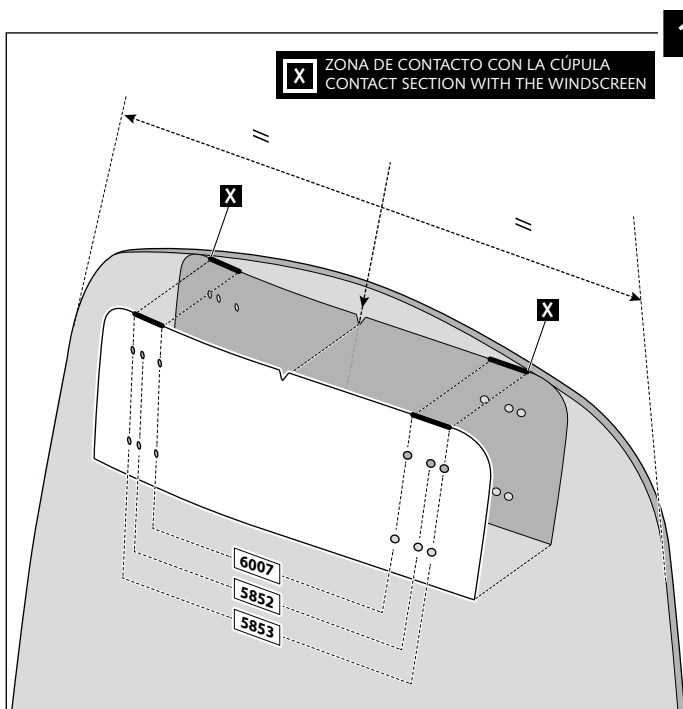

VISERA MULTIREGULABLE MULTI-ADJUSTABLE VISOR

INSTRUCCIONES DE MONTAJE - MOUNTING INSTRUCTIONS - MONTAGEANLEITUNG

TIPO/TYPER C - TIPO/TYPER C - TIPO/TYPER C

