



ALLGEMEINE BETRIEBSERLAUBNIS

ABE 38182 - VS
Nachtrag 26
April 2022

MOTOPLASTIC, S.A.

Passeig de la Ribera, 29
08403 GRANOLLERS - BARCELONA/ ESPAÑA
Tels: 00-34-93 849 06 33 / 00-34-93 849 08 77
Fax: 00-34-93 849 09 88
www.puig.tv
info@puig.tv



Kraftfahrt-Bundesamt

DE-24932 Flensburg

Allgemeine Betriebserlaubnis (ABE) National Type Approval

ausgestellt von:

Kraftfahrt-Bundesamt (KBA)

nach § 22 in Verbindung mit § 20 Straßenverkehrs-Zulassungs-Ordnung (StVZO)
für einen Typ des folgenden Genehmigungsobjektes

Windschild

issued by:

Kraftfahrt-Bundesamt (KBA)

according to § 22 and 20 Straßenverkehrs-Zulassungs-Ordnung (StVZO) for a type
of the following approval object

windshield

Genehmigungsnummer: **38182*26**

Approval number:

1. Genehmigungsinhaber:
Holder of the approval:
Motoplastic S.A.
ES - 08400 Granollers (Barcelona)/Spanien
2. Gegebenenfalls Name und Anschrift des Bevollmächtigten:
If applicable, name and address of representative:
Entfällt
Not applicable
3. Typbezeichnung:
Type:
VS



Kraftfahrt-Bundesamt

DE-24932 Flensburg

2

Genehmigungsnummer: **38182*26**

Approval number:

4. Aufgebrachte Kennzeichnungen:
Identification markings:
Hersteller oder Herstellerzeichen
Manufacturer or registered manufacturer`s trademark

Typ und die Ausführung
Type and version

Genehmigungszeichen
Approval identification

5. Anbringungsstelle der Kennzeichnungen:
Position of the identification markings:
Siehe Punkt 1.1.1 des Prüfberichtes
See point 1.1.1 of the test report

6. Zuständiger Technischer Dienst:
Responsible Technical Service:
Technischer Dienst der TÜV Rheinland Kraftfahrt GmbH
DE-51105 Köln

7. Datum des Prüfberichts des Technischen Dienstes:
Date of test report issued by the Technical Service:
01.04.2022

8. Nummer des Prüfberichts des Technischen Dienstes:
Number of test report issued by that Technical Service:
124KA0007-01

9. Verwendungsbereich:
Range of application:
Das Genehmigungsobjekt „Windschild“ darf nur zur Verwendung gemäß:
The use of the approval object „windshield“ is restricted to the application listed:

Punkt 2.3 des Prüfberichtes
Point 2.3 of the test report

unter den angegebenen Bedingungen an den dort aufgeführten bzw. beschriebenen Kraftfahrzeugen feilgeboten werden.
The offer for sale is only allowed on the listed vehicles under the specified conditions.



Kraftfahrt-Bundesamt

DE-24932 Flensburg

3

Genehmigungsnummer: **38182*26**

Approval number:

10. Bemerkungen:

Remarks:

**Es gelten die im o.g. Gutachten nebst Anlagen festgehaltenen Angaben.
The indications given in the above mentioned test report including its annexes shall apply.**

Die Anforderungen des Artikels 51, Absätze 1, 2, 4, 5 der Verordnung (EU) Nr. 168/2013 - Teile oder Ausrüstungen, von denen ein erhebliches Risiko für das einwandfreie Funktionieren wesentlicher Systeme ausgehen kann - weitere Anforderungen - sind sinngemäß erfüllt.

The requirements of Article 51, paragraphs 1, 2, 4, 5 of the Regulation (EU) No 168/2013 - Parts or equipment that may pose a serious risk to the correct functioning of essential systems - related requirements - are met.

11. Änderungsabnahme gemäß § 19 (3) StVZO:

Acceptance test of the modification as per § 19 (3) StVZO:

**Nicht notwendig
Not required**

12. Die Genehmigung wird **erweitert**

Approval is **extended**

13. Grund (Gründe) für die Erweiterung der Genehmigung (falls zutreffend):

Reason(s) for the extension (if applicable):

**Aktualisierung des Verwendungsbereiches
Update of the range of application**

**Aktualisierung der Ausführungen
Update of the remarks**

14. Ort: **DE-24932 Flensburg**

Place:

15. Datum: **11.04.2022**

Date:

16. Unterschrift: **Im Auftrag**

Signature:

Nino Pommerencke





Kraftfahrt-Bundesamt

DE-24932 Flensburg

4

Genehmigungsnummer: **38182*26**

Approval number:

Anlagen:

Enclosures:

Gemäß Inhaltsverzeichnis

According to index



Kraftfahrt-Bundesamt

DE-24932 Flensburg

Inhaltsverzeichnis zu den Beschreibungsunterlagen Index to the information package

Nummer der Genehmigung: **38182*26**
Approval No.

Ausgabedatum: **03.06.1998**
Date of issue:

letztes Änderungsdatum: **11.04.2022**
last date of amendment:

Nebenbestimmungen und Rechtsbehelfsbelehrung
Collateral clauses and instruction on right to appeal

Prüfbericht(e) Nr.: Test report(s) No.:	Datum: Date
Gutachten	20.04.1998
ohne / without	14.09.1998
Nachtragsgutachten 01	29.03.1999
Nachtragsgutachten 02	31.01.2000
Nachtragsgutachten 03	07.03.2001
Nachtragsgutachten 04	12.06.2002
Nachtragsgutachten 05	05.11.2003
Nachtragsgutachten 06	15.11.2004
Nachtragsgutachten 07	20.12.2005
Nachtragsgutachten 08	14.03.2007
08-7049-00-01	14.04.2008
08-7049-00-01	03.02.2009
08-7049-00-01	18.02.2010
08-7049-00-01	14.06.2011
08-7049-00-01	14.07.2011
124KA0007	04.05.2012
124KA0007	26.02.2013
124KA0007	25.03.2014
124KA0007	23.03.2015
124KA0007	22.03.2016
124KA0007	30.05.2017
124KA0007	25.04.2018
124KA0007	01.02.2019
124KA0007	31.10.2019
124KA0007	04.06.2020
124KA0007	19.04.2021
124KA0007-01	01.04.2022

Beschreibungsbogen Nr.:	Datum:
Information document No.:	Date
Entfällt	
Not applicable	



Kraftfahrt-Bundesamt

DE-24932 Flensburg

2

Nummer der Genehmigung: **38182*26**
Approval No.

Liste der Änderungen:

List of modifications:

Siehe Anlage "Liste der Änderungen" des Prüfberichtes

See appendix "List of modifications" of the test report

Datum:

Date



Kraftfahrt-Bundesamt

DE-24932 Flensburg

Nummer der Genehmigung: **38182*26**

- Anlage -

Nebenbestimmungen und Rechtsbehelfsbelehrung

Nebenbestimmungen

Jede Einrichtung, die dem genehmigten Typ entspricht, ist gemäß der angewendeten Vorschrift zu kennzeichnen.

Das Genehmigungszeichen lautet wie folgt:

KBA 38182

Die Einzelerzeugnisse der reihenweisen Fertigung müssen mit den Genehmigungsunterlagen genau übereinstimmen. Änderungen an den Einzelerzeugnissen sind nur mit ausdrücklicher Zustimmung des Kraftfahrt-Bundesamtes gestattet.

Änderungen der Firmenbezeichnung, der Anschrift und der Fertigungsstätten sowie eines bei der Erteilung der Genehmigung benannten Zustellungsbevollmächtigten oder bevollmächtigten Vertreters sind dem Kraftfahrt-Bundesamt unverzüglich mitzuteilen.

Verstöße gegen diese Bestimmungen können zum Widerruf der Genehmigung führen und können überdies strafrechtlich verfolgt werden.

Die Genehmigung erlischt, wenn sie zurückgegeben oder entzogen wird, oder der genehmigte Typ den Rechtsvorschriften nicht mehr entspricht. Der Widerruf kann ausgesprochen werden, wenn die für die Erteilung und den Bestand der Genehmigung geforderten Voraussetzungen nicht mehr bestehen, wenn der Genehmigungsinhaber gegen die mit der Genehmigung verbundenen Pflichten - auch soweit sie sich aus den zu dieser Genehmigung zugeordneten besonderen Auflagen ergeben - verstößt oder wenn sich herausstellt, dass der genehmigte Typ den Erfordernissen der Verkehrssicherheit oder des Umweltschutzes nicht entspricht.

Das Kraftfahrt-Bundesamt kann jederzeit die ordnungsgemäße Ausübung der durch diese Genehmigung verliehenen Befugnisse, insbesondere die genehmigungsgerechte Fertigung sowie die Maßnahmen zur Übereinstimmung der Produktion, nachprüfen. Es kann zu diesem Zweck Proben entnehmen oder entnehmen lassen. Dem Kraftfahrt-Bundesamt und/oder seinen Beauftragten ist ungehinderter Zutritt zu Produktions- und Lagerstätten zu gewähren.

Die mit der Erteilung der Genehmigung verliehenen Befugnisse sind nicht übertragbar. Schutzrechte Dritter werden durch diese Genehmigung nicht berührt.

Rechtsbehelfsbelehrung

Gegen diese Genehmigung kann innerhalb eines Monats nach Bekanntgabe Widerspruch erhoben werden. Der Widerspruch ist beim **Kraftfahrt-Bundesamt, Fördestraße 16, DE-24944 Flensburg**, schriftlich oder zur Niederschrift einzulegen.



Kraftfahrt-Bundesamt

DE-24932 Flensburg

2

Approval No.: **38182*26**

- Attachment -

Collateral clauses and instruction on right to appeal

Collateral clauses

All equipment which corresponds to the approved type is to be identified according to the applied regulation.

The approval identification is as follows: - see German version -

The individual production of serial fabrication must be in exact accordance with the approval documents. Changes in the individual production are only allowed with express consent of the Kraftfahrt-Bundesamt.

Changes in the name of the company, the address and the manufacturing plant as well as one of the parties given the authority to delivery or authorised representative named when the approval was granted is to be immediately disclosed to the Kraftfahrt-Bundesamt.

Breach of this regulation can lead to recall of the approval and moreover can be legally prosecuted.

The approval expires if it is returned or withdrawn or if the type approved no longer complies with the legal requirements. The revocation can be made if the demanded requirements for issuance and the continuance of the approval no longer exist, if the holder of the approval violates the duties involved in the approval, also to the extent that they result from the assigned conditions to this approval, or if it is determined that the approved type does not comply with the requirements of traffic safety or environmental protection.

The Kraftfahrt-Bundesamt may check the proper exercise of the conferred authority taken from this approval at any time. In particular this means the compliant production as well as the measures for conformity of production. For this purpose samples can be taken or have taken. The employees or the representatives of the Kraftfahrt-Bundesamt may get unhindered access to the production and storage facilities.

The conferred authority contained with issuance of this approval is not transferable. Trade mark rights of third parties are not affected with this approval.

Instruction on right to appeal

This approval can be appealed within one month after notification. The appeal is to be filed in writing or as a transcript at the **Kraftfahrt-Bundesamt, Fördestraße 16, DE-24944 Flensburg.**

Fahrzeugtyp / Typ : VS
Hersteller : Motoplastic S.A.

PRÜFBERICHT

gemäß §22 StVZO in Verbindung mit §20 StVZO

über die Erteilung eines Nachtrags zur ABE über Verkleidungsscheiben zum
nachträglichen Anbau an Krafträdern

Genehmigungsstand

EU -Typgenehmigung
UNECE Genehmigung : 38182*26
Nationale Genehmigung

Gliederung des Prüfberichts

Absatz Nr.

- | | |
|---|----------------------|
| 0 | Allgemeine Angaben |
| 1 | Prüfobjekt |
| 2 | Prüfprotokoll |
| 3 | Anlagen |
| 4 | Schlussbescheinigung |
-

Dieser Prüfbericht darf nur vom Auftraggeber und nur in vollem Wortlaut vervielfältigt und veröffentlicht werden. Eine auszugsweise Vervielfältigung und Veröffentlichung des Prüfberichtes ist nur nach schriftlicher Genehmigung des Technischen Dienstes zulässig.

Fahrzeugtyp / Typ : VS
 Hersteller : Motoplastic S.A.

0 Allgemeine Angabe

- 0.1 Fabrikmarke (Firmenname des Herstellers) : Motoplastic S.A.
- 0.2 Typ : VS
- 0.3 Fahrzeugklasse : entfällt
- 0.4 Name und Anschrift des Herstellers : Motoplastic S.A.
 Passeig de la Ribera 29
 E-08403 Granollers, Barcelona
- 0.5 Beschreibungsbogen-Nr. : entfällt

1 Prüfobjekt

- 1.1 Beschreibung
- 1.1.1 Objekt : Windschilde in unterschiedlichen Abmessungen zum Anbau an Kraffradverkleidungen; Verwendung gemäß Anlage 1/26
- Handelsbezeichnung : Verkleidungsscheibe
- Typ : VS
- Ausführungen : VS1 = Standard
 VS2 = Touring
 VS2.1 = Touring mit Aufsatz 6007
 VS2.2 = Touring mit Aufsatz 5852
 VS2.3 = Touring mit Aufsatz 5853
 VS2.4 = Touring mit Aufsatz 20763
 VS3 = Racing
- Werkstoff : Polymethylmethacrylat (PMMA)
- Kennzeichnung, Beispiel : Motoplastic S.A.
 VS
 VS3
 KBA 38182
- Art der Kennzeichnung : eingeprägt, Lasergravur oder Klebeetikett
- 1.2 Auswahl des ungünstigsten Falles : Für den Anbau und die Sicht über die Scheibe wird bei den hinzukommenden Modellen die Windschild-Ausführung mit der größten Höhe überprüft.
- Für die Fahrversuche werden Kraffräder der verschiedenen EG- Fahrzeugklassen mit möglichst hoher Leistung in Kombination mit den flächenmäßig größten Windschilden des Verwendungsbereichs ausgewählt.

Fahrzeugtyp / Typ : VS
 Hersteller : Motoplastic S.A.

1.3 Bemerkungen : Scheiben mit Zusatzkennung .1, .2, .3, .4 sind vom Antragsteller werkseitig mit einem verstellbaren Windschild-Aufsatz ausgestattet, der Fest mit der Basisscheibe (VS2) verschraubt ist.

2 Prüfprotokoll

2.1 Prüf- und Messgeräte : Die verwendeten Prüf- und Messgeräte entsprachen den Prüfanforderungen.

2.2 Prüfergebnisse : Die Prüfungen wurden nach dem VdTÜV-Merkblatt 736 "Verkleidungen für Krafträder", Ausgabe 08.2009 durchgeführt. Die dort gestellten Anforderungen werden eingehalten.

2.2.1 Materialprüfung gemäß TA 29, Absatz 3.6.8 : Die Verkleidungsscheiben genügen im Hinblick auf das Bruch- und Splitterverhalten den in der TA 29 festgehaltenen Anforderungen.

2.2.2 Äußere Gestaltung gemäß VO (EU) 44/2014, Anhang VIII : Alle freiliegenden Kanten der Verkleidungsscheibe sind mit einem Verrundungsradius von 2mm versehen. Die Anforderungen der Punkte 1.3.2 und 1.3.3 der genannten Verordnung werden ab einer Scheibendicke von 3mm auch ohne Kantenschutz erfüllt

2.2.3 Sichtfeldmessung gemäß VdTÜV-Merkblatt 736 i.V.m. §35b StVZO : Das Sichtfeld wird nicht eingeschränkt, die Sicht über die Scheibe ist gewährleistet.

2.2.4 Anforderungen an Betätigungseinrichtungen gemäß VO (EU) Nr.3/2014, Anh VIII : Durch den Anbau werden die Betätigungseinrichtungen und Bedienteile nicht beeinträchtigt.

2.2.5 Steuerfähigkeit, Kurvenfahreigenschaften, Wendefähigkeit gemäß VO (EU), Nr. 3/2014, Anh XIV : Mit ausgewählten Prüffahrzeugen des Verwendungsbereichs wurde das Fahrverhalten überprüft. Dabei wurden bis zur Höchstgeschwindigkeit der Prüffahrzeuge keine negativen Einflüsse auf das Fahrverhalten festgestellt.

2.2.6 Höchstgeschwindigkeit : Die Höchstgeschwindigkeit der im Verwendungsbereich aufgeführten Fahrzeuge ändert sich im Rahmen der zulässigen Messtoleranzen nicht.

2.2.7 Anbau und Befestigung : Der Anbau erfolgt an den serienmäßig vom Hersteller vorgegebenen Befestigungspunkten. Es ist nach der Montageanleitung des Antragstellers zu verfahren.

Fahrzeugtyp / Typ : VS
Hersteller : Motoplastic S.A.

- 2.2.8 Lichttechnische Einrichtungen gemäß VO (EU) Nr. 3/2014, Anh IX : Scheinwerfer:
 Die Wirksamkeit der serienmäßig vorhandenen Scheinwerfer wird durch den Anbau der Windschilde nicht beeinträchtigt.
- Fahrtrichtungsanzeiger:
 Die geometrische Sichtbarkeit der Fahrtrichtungsanzeiger bleibt auch bei angebauter Scheibe erhalten.
- 2.2.9 Weitere Fahrzeugteile : Spiegel:
 Der Anbau der Spiegel verbleibt in serienmäßigem Zustand.
- Instrumente:
 Die Sicht auf die vorgeschriebenen Instrumente ändert sich nicht.
- Lenker:
 Die Lenker- Freiräume werden nicht eingeschränkt
- 2.3 Verwendungsbereich : Die Verkleidungsscheiben sind zum Anbau an den in Anlage 1/26 aufgeführten Kraffradtypen unter den dort genannten Bedingungen geeignet.
- 2.4 Zusätzliche Angaben
- Ort der Prüfung : Sulzbach
- Datum der Prüfung : KW 6, 9, 13 2022

Fahrzeugtyp / Typ : VS
Hersteller : Motoplastic S.A.

3 Anlagen

- Anlage 0/26 : Liste der Änderungen
- Anlage 1/26 : Verwendungsbereich
- Anlage 2/26 : Zeichnungen neuer Ausführungen
- Anlage 3/26 : Montageanleitungen neuer Ausführungen

§22 38182*26

Fahrzeugtyp / Typ : VS
Hersteller : Motoplastic S.A.

4 Schlussbescheinigung

Eine Abnahme des Anbaus und eine entsprechende Berichtigung der Fahrzeugpapiere ist bei solchen Fahrzeugen erforderlich, bei denen „EBE“ in der Spalte ABE-Nr. / EG- BE im Verwendungsbereich angegeben ist.

Bei allen anderen wird die Abnahme des Anbaus durch einen amtlich anerkannten Sachverständigen oder Prüfer für den Kraftfahrzeugverkehr oder einen Kraftfahrzeugsachverständigen bzw. Angestellten nach Abschnitt 4 der Anlage VIII b zur StVZO nicht für erforderlich gehalten.

Die in den genannten Anlagen zu Abschnitt 3 aufgeführten Fahrzeuge entsprechen den heute gültigen Vorschriften der StVZO sowie den hierzu vom Bundesministerium ergangenen Richtlinien und Anweisungen.

Die betroffenen Forderungen der VO (EU), Nr. 168/2013 sind ebenfalls eingehalten.

Gegen die Erteilung einer ABE bestehen für die im Verwendungsbereich genannten Fahrzeuge bei Beachtung der Montageanleitung keine technischen Bedenken.

Lambsheim, den 01.04.2022



Kai Laborenz
amtlich anerkannter Sachverständiger
Technischer Dienst

Anlage 0/26

Liste der Änderungen zum Gutachten 124KA0007-01

Es wird berichtigt :

--

Es wird geändert :

Aktualisierung des Prüfberichts und der Daten von Fahrzeugen und Windschildern im Verwendungsbereich gemäß Anlage 1/26

Es wird hinzugefügt :

Der Verwendungsbereich gemäß Anlage 1/26 wird um neue Fahrzeuge und Windschilder ergänzt
Ein neuer Aufsatz für Touringscheiben kommt hinzu (VS2.4)

Es entfällt :

--

Hersteller	Handelsbezeichnung	Fahrzeugtyp	ABE- Nr. / EG- BE	Baujahr		VS1		VS2		VS2.1, VS2.2, VS2.3, VS2.4		VS3	
				von	bis	STANDARD		TOURING		TOURING		RACING	
						HxB	Teile-Nr.	HxB	Teile-Nr.	HxB	Teile-Nr.	HxB	Teile-Nr.
APRILIA	siehe auch Piaggio												
APRILIA	RS 50	HP	G797	97	-	355x405	0112	---	---	---	---	---	---
APRILIA	RS 50	PG	K267	99	-	380x340	0549	---	---	---	---	320x380	1091
APRILIA	RS 50	RL	e3*0012*	2000	-	380x340	0549	---	---	---	---	320x380	1091
APRILIA	RS 50	TS	EBE	2006	-	---	---	---	---	---	---	400x300	4183
APRILIA	SR 50	MZ	H638		99	235x332	0781	---	---	---	---	---	---
APRILIA	SR 50	RL	e3*0012*	2000	-	240x370	0345	---	---	---	---	---	---
APRILIA	Leonardo 125	MB	H287		99	235x330	0781	---	---	---	---	---	---
APRILIA	Leonardo 125	TB	e3*0124*	2000	-	240x370	0345	---	---	---	---	---	---
APRILIA	RS 125	MP	H356	96	-	380x340	0549	---	---	---	---	---	---
APRILIA	RS 125	MP	H792	98	-	380x340	0549	---	---	---	---	320x380	1091
APRILIA	Leonardo 150	TB	e3*0124*	2002	-	235x331	0781	---	---	---	---	---	---
APRILIA	Leonardo 250	SV	e11*00063*	2002	-	235x331	0781	---	---	---	---	---	---
APRILIA	Leonardo 300	SV	e11*00063*	2002	-	235x331	0781	---	---	---	---	---	---
APRILIA	RS 250	LD	G897*02 -	97	-	380x340	0549	---	---	---	---	320x380	1091
APRILIA	Pegaso 650	ML	H523	97	-	295x330	0362	400x350	0853	---	---	---	---
APRILIA	Pegaso 650 i.e.	RW	e11*00032*	2002	-	295x330	0362	400x350	0853	---	---	---	---
APRILIA	RSV 1000 mille	ME	H827	97	-	390x350	0264	395x360	0562	---	---	385x380	0962
APRILIA	RSV 1000 R	RP	e11*00027*	2000	-	395x325	0248	420x330	0553	---	---	400x320	0963
APRILIA	RSV 1000 Tuono	RP	e11*00027*	2002	-	---	---	---	---	---	---	400x270	4110
APRILIA	RSV 1000 R	RR	e11*00093*	2003	-	440x345	1619	---	---	---	---	440x340	1620
APRILIA	SL 1000 Falco	PA	e11*0749*	99	-	480x385	0973	515x380	0987	---	---	---	---
BENELLI	TRK 251	N30	e13*00537 (VO)	2020	-	---	---	580x340	20629	600x340	20630	---	---
BENELLI	TRK 502	P16	e13*00123 (VO)	2017	-	---	---	555x385	9485	555x385	9508	---	---
BENELLI	TORNADO 302R	P13	e13*00125 (VO)	2017	-	---	---	---	---	---	---	373x340	9591
BMW	G 310 GS	5G31	e1*00052 (VO)	2017	-	---	---	430x340	9879	430x340	9880	---	---
BMW	F 650	BMW 169	G532		96	---	---	565x445	0297	---	---	---	---
BMW	F 650 protection	BMW 169	G532		96	---	---	490x400	0118	---	---	---	---
BMW	F 650, ST	BMW 169	G532	97	-	---	---	500x410	0307	---	---	---	---
BMW	F 650 CS	E650C	e1*0201*	2004	-	---	---	465x335	2016	---	---	---	---
BMW	F 650 GS, Dakar	R 13	e1*00061*	2000	-	---	---	415x335	0172	---	---	---	---
BMW	F 650 GS, Dakar	E650G	e1*0200*	2004	-	280x300	2014	440x305	2015	---	---	---	---

Hersteller	Handelsbezeichnung	Fahrzeugtyp	ABE- Nr. / EG- BE	Baujahr		VS1		VS2		VS2.1, VS2.2, VS2.3, VS2.4		VS3	
				von	bis	STANDARD		TOURING		TOURING		RACING	
						HxB	Teile-Nr.	HxB	Teile-Nr.	HxB	Teile-Nr.	HxB	Teile-Nr.
BMW	F 650 GS	E8GS	e1*0352*	2008	-	---	---	300x200	4670	300x200	5914	---	---
BMW	G 650 GS	E650G	e1*0200*	2010	-	---	---	440x305	2015	---	---	---	---
BMW	G 650 GS	E650G	e1*0200*	2011	-	---	---	420x450	5649	420x450	5915	---	---
BMW	F 700 GS	E8GS	e1*0352*	2012	2017	---	---	490x400	6365	490x400	6715	---	---
BMW	F 700 GS	4G80	e1*00019 (VO)	2016	-	---	---	490x400	6365	490x400	6715	---	---
BMW	F 700 GS	4G80	e1*00021 (VO)	2016	-	---	---	490x400	6365	490x400	6715	---	---
BMW	F 700 GS	4G80r	e1*00020 (VO)	2016	-	---	---	490x400	6365	490x400	6715	---	---
BMW	F 700 GS	4G80r	e1*00022 (VO)	2016	-	---	---	490x400	6365	490x400	6715	---	---
BMW	F 750 GS	4G85	e1*00058 (VO)	2018	-	---	---	530x412	9770	570x558	9771	---	---
BMW	F 750 GS	4G85	e1*00059 (VO)	2018	-	---	---	530x412	9770	570x558	9771	---	---
BMW	F 750 GS	4G85	e1*00058 (VO)	2018	-	---	---	570x420	3178				
BMW	F 750 GS	4G85	e1*00058 (VO)	2018	-	---	---	410x365	3768	440x365	3832		
BMW	F 750 GS	4G85	e1*00059 (VO)	2018	-	---	---	570x420	3178				
BMW	F 750 GS	4G85	e1*00059 (VO)	2018	-	---	---	410x365	3768	440x365	3832		
BMW	F 800 R	E8ST	e1*0283*02	2009	-	---	---	---	---	---	---	360x280	5051
BMW	F 800 S , ST	E8ST	e1*0283*	2006	-	---	---	---	---	---	---	390x330	4376
BMW	F 800 GS	E8GS	e1*0352*	2007	-	---	---	300x200	4670	300x200	5914	---	---
BMW	F 800 GS	4G80	e1*00019 (VO)	2016	-	---	---	300x200	4670	300x200	5914	---	---
BMW	F 800 GS	4G80	e1*00021 (VO)	2016	-	---	---	300x200	4670	300x200	5914	---	---
BMW	F 800 GS	4G80r	e1*00020 (VO)	2016	-	---	---	300x200	4670	300x200	5914	---	---
BMW	F 800 GS	4G80r	e1*00022 (VO)	2016	-	---	---	300x200	4670	300x200	5914	---	---
BMW	F850 GS, Adventure	4G85	e1*00058 (VO)	2018	-	---	---	540x415	3595	597x415	3597	---	---
BMW	F850 GS, Adventure	4G85	e1*00059 (VO)	2018	-	---	---	540x415	3595	597x415	3597	---	---
BMW	F850 GS, Adventure	4G85	e1*00058 (VO)	2018	-	---	---	570x420	3179	---	---	---	---
BMW	F850 GS, Adventure	4G85	e1*00058 (VO)	2018	-	---	---	410x365	3769	440x365	3831		
BMW	F850 GS, Adventure	4G85	e1*00059 (VO)	2018	-	---	---	570x420	3179	---	---	---	---
BMW	F850 GS, Adventure	4G85	e1*00059 (VO)	2018	-	---	---	410x365	3769	440x365	3831		
BMW	F 800 GT	E8ST	e1*0283*02	2009	-	---	---	610x370	6485	610x370	6503	---	---
BMW	F 800 GT	4R80	e1*00029 (VO)	2017	-	---	---	610x370	6485	610x370	6503	---	---
BMW	F 800 GT	4R80	e1*00030 (VO)	2017	-	---	---	610x370	6485	610x370	6503	---	---
BMW	F 900 R, XR	4R90	e1*00167 (VO)	2020	-	---	---	565x360	20391	565x360	20392	378x355	20429
BMW	F 900 R, XR	4R90r	e1*00168 (VO)	2020	-	---	---	565x360	20391	565x360	20392	378x355	20429
BMW	S 1000 RR	K10	e1*0421*	2009	-	---	---	420x450	5649	---	---	430x300	5205
BMW	S 1000 RR	K10	e1*0421*	2015	-	---	---	---	---	---	---	360x440	7564

S22_38182*26

Hersteller	Handelsbezeichnung	Fahrzeugtyp	ABE- Nr. / EG- BE	Baujahr		VS1		VS2		VS2.1, VS2.2, VS2.3, VS2.4		VS3	
				von	bis	STANDARD		TOURING		TOURING		RACING	
						HxB	Teile-Nr.	HxB	Teile-Nr.	HxB	Teile-Nr.	HxB	Teile-Nr.
BMW	S 1000 RR	2R10	e1*00012 (VO)	2017	-	---	---	---	---	---	---	360x440	7564
BMW	S 1000 RR	2R10r	e1*00013 (VO)	2017	-	---	---	---	---	---	---	360x440	7564
BMW	S 1000 RR	2R99	e1*00091 (VO)	2019	-	---	---	---	---	---	---	445x425	3571
												450X430	3641
BMW	S 1000 RR	2R99r	e1*00092 (VO)	2019	-	---	---	---	---	---	---	445x425	3571
												450X430	3641
BMW	S 1000 R	K10	e1*0421*	2014	-	---	---	---	---	---	---	250x250	7040
BMW	S 1000 R	2R10	e1*00012 (VO)	2017	-	---	---	---	---	---	---	250x250	7040
BMW	S 1000 R	2R10r	e1*00013 (VO)	2017	-	---	---	---	---	---	---	250x250	7040
BMW	S 1000 XR	K10	e1*0421*	2015	-	---	---	515x425	7619	515x425	7620	390x345	8543
BMW	S 1000 XR	2X10	e1*00014 (VO)	2017	-	---	---	515x425	7619	515x425	7620	390x345	8543
BMW	S 1000 XR	2X10r	e1*00015 (VO)	2017	-	---	---	515x425	7619	515x425	7620	390x345	8543
BMW	S 1000 XR	2X99	e1*00162 (VO)	2020	-	---	---	565x360	20447	590x360	20456	378x335	20460
BMW	S 1000 XR	2X99r	e1*00163 (VO)	2020	-	---	---	565x360	20447	590x360	20456	378x335	20460
BMW	R NINE T Racer	1N12	e1*00009 (VO)	2016	-	---	---	---	---	---	---	385x360	9402
BMW	R 1100 GS	BMW 259	G239	1992	-	---	---	510x400	0295	---	---	---	---
BMW	R 1100 RS	BMW 259	G239	1992	-	---	---	445x450	0470	---	---	---	---
BMW	R 1100 S	BMW R2S	K083	1998	-	350x365	0803	450x420	0810	---	---	---	---
BMW	R 1150 RT	R 22	e1*00101*	2001	-	---	---	490x530	2005	---	---	---	---
BMW	R 1200 RT	R12WT	e1*0613*	2014	-	---	---	695x680	7525	695x680	7527	---	---
BMW	R 1200 RT	1T12	e1*00007 (VO)	2016	-	---	---	695x680	7525	695x680	7527	---	---
BMW	R 1250 RT	1T13	e1*00093 (VO)	2018	2020	---	---	700x660	9512	700x660	9513	---	---
BMW	R 1250 RT	1T13	e1*00093 (VO)	2021	-	---	---	690x675	20774	735x675	20775	---	---
BMW	R 1150 RS	R 22	e1*00101*	2001	-	---	---	490x400	2006	---	---	---	---
BMW	R 1150 RS	R11RT	e1*0215*	2004	-	---	---	490x400	2006	---	---	---	---
BMW	R 1150 GS	R11R	e1*0216*	2004	-	---	---	540x430	4878	---	---	---	---
BMW	R 1150 GS	R21	e1*00041*	1999	-	---	---	540x430	4878	540x430	5917	---	---
BMW	R 1200 GS	R12	e1*0199*	2003	-	395x456	2007	425x456	2013	---	---	---	---
BMW	R 1200 GS	R12	e1*0199*	2003	-	---	---	530x460	4331	530x460	5916	---	---
BMW	R 1200 GS	R12W	e1*0584*	2013	-	---	---	545x445	6486	565x445	6504	320x340	6487
BMW	R 1200 GS Adventure	R12W	e1*0584*	2014	-	---	---	545x445	6486	565x445	6504	320x340	6487
BMW	R 1200 GS	1G12	e1*00006 (VO)	2016	-	---	---	545x445	6486	565x445	6504	320x340	6487
BMW	R 1200 GS Adventure	1G12	e1*00006 (VO)	2016	-	---	---	545x445	6486	565x445	6504	320x340	6487
BMW	R 1250 GS	1G13	e1*00071 (VO)	2018	-	---	---	545x445	6486	565x445	6504	320x340	6487

S22_38182*26

Hersteller	Handelsbezeichnung	Fahrzeugtyp	ABE- Nr. / EG- BE	Baujahr		VS1		VS2		VS2.1, VS2.2, VS2.3, VS2.4		VS3	
				von	bis	STANDARD		TOURING		TOURING		RACING	
						HxB	Teile-Nr.	HxB	Teile-Nr.	HxB	Teile-Nr.	HxB	Teile-Nr.
BMW	R 1250 GS Adventure	1G13	e1*00071 (VO)	2018	-	---	---	545x445	6486	565x445	6504	320x340	6487
BMW	R 1250 GS Adventure	1G13ind	e1*00169 (VO)	2019	-	---	---	545x445	6486	565x445	6504	320x340	6487
BMW	R 1200 S	R12S	e1*0284*	2006	-	---	---	---	---	---	---	340x340	4375
BMW	R 1200 RS	R12WR	e1*0650*	2015	-	---	---	550x410	7617	550x410	7618	440x390	7616
BMW	R 1200 RS	1R12	e1*00008 (VO)	2017	-	---	---	550x410	7617	550x410	7618	440x390	7616
BMW	R 1250 RS	1R13	e1*00094 (VO)	2018	-	---	---	550x410	7617	550x410	7618	440x390	7616
BMW	R 1250 RS	1R13ind	e1*00171 (VO)	2019	-	---	---	550x410	7617	550x410	7618	440x390	7616
BMW	HP2 Sport	R12S	e1*0284*	2008	-	---	---	---	---	---	---	310x320	4668
BMW	K 1200 R Sport	K12R	e1*0234*	2007	-	---	---	---	---	---	---	360x450	4669
BMW	K 1200 S	K12S	e1*0217*	2004	-	430x430	2206	---	---	---	---	430x430	2207
BMW	K 1300 S	K12S	e1*0217*	2009	-	---	---	---	---	---	---	430x430	2207
BMW	K 1300 R	K12S	e1*0217*	2009	-	---	---	---	---	---	---	230x310	4940
BMW	K 1600 GT (Sport, Execut.)	K16GT	e1*0498*	2011	-	---	---	700x660	9512	700x660	9513	---	---
BMW	K 1600 GT, GTL	2T16	e1*00010 (VO)	2016	-	---	---	700x660	9512	700x660	9513	---	---
BMW	K 1600 GT, GTL	2T16r	e1*00011 (VO)	2016	-	---	---	700x660	9512	700x660	9513	---	---
CAGIVA	Mito 50	8P	EBE		2001	320x340	0342	---	---	---	---	---	---
DERBI	siehe Nacional Motor												
DUCATI	620 Sport	V 5	e3*0142*	2003	-	390x370	0176	390x370	0182	---	---	---	---
DUCATI	748 Strada	748	H199	95-		335x305	0954	---	---	---	---	340x310	0955
DUCATI	748 SP, SPS	ZDM 748...	EBE	94-		335x305	0954	---	---	---	---	340x310	0955
DUCATI	748 Strada	H3	e1*00037*	99-		335x305	0954	---	---	---	---	340x310	0955
DUCATI	749, 749S	H5 1)	e3*0153*	2002	-	410x310	1347	450x310	1348	---	---	410x320	1349
DUCATI	749, 749S, 749R	H5 1)	e3*0153*	2005	-	330x315	2540	---	---	---	---	420x330	2541
DUCATI	750 SS, i.e.	V 2	e1*00026	98-		390x370	0176	390x370	0182	---	---	---	---
DUCATI	Monster 696	M5	e3*0497*	2008	-	160x220	5890	---	---	---	---	260x220	5650
DUCATI	Monster 796	M5	e3*0497*	2008	-	160x220	5890	---	---	---	---	260x220	5650
DUCATI	Monster 797	MD	e49*00021 (VO)	2017	-	---	---	---	---	---	---	270x190	8900
DUCATI	Monster 821	M2	e9*6044*	2014	-	---	---	---	---	---	---	270x190	8900
DUCATI	Monster 821	M6	e9*6025*	2014	-	---	---	---	---	---	---	270x190	8900
DUCATI	Monster 821	M7	e9*6038*	2014	-	---	---	---	---	---	---	270x190	8900

S22 38182*26

Hersteller	Handelsbezeichnung	Fahrzeugtyp	ABE- Nr. / EG- BE	Baujahr		VS1		VS2		VS2.1, VS2.2, VS2.3, VS2.4		VS3	
				von	bis	STANDARD		TOURING		TOURING		RACING	
						HxB	Teile-Nr.	HxB	Teile-Nr.	HxB	Teile-Nr.	HxB	Teile-Nr.
DUCATI	Monster 821	MC	e9*11002 (VO)	2016	-	---	---	---	---	---	---	270x190	8900
DUCATI	Monster 821	MC	e9*11003 (VO)	2016	-	---	---	---	---	---	---	270x190	8900
DUCATI	Monster 821	MF	e49*00027 (VO)	2019	-	---	---	---	---	---	---	270x190	8900
DUCATI	Monster 821	MG	e49*00028 (VO)	2019	-	---	---	---	---	---	---	270x190	8900
DUCATI	Monster 821	MH	e49*00034 (VO)	2019	-	---	---	---	---	---	---	270x190	8900
DUCATI	Monster 821	MJ	e49*00035 (VO)	2019	-	---	---	---	---	---	---	270x190	8900
DUCATI	Monster 821	MK	e49*00036 (VO)	2019	-	---	---	---	---	---	---	270x190	8900
DUCATI	800 SS	V5	e3*0142*	98-		390x370	0176	390x370	0182	---	---	---	---
DUCATI	821 Hyperstrada	B2	e9*0601*	2013	-	---	---	---	---	---	---	450x320	6492
DUCATI	848	H6	e3*0475*	2008	-	---	---	---	---	---	---	435x330	4667
DUCATI	899 Panigale	H8	e3*0586*	2014	-	---	---	---	---	---	---	400x250	5990
DUCATI	900 SS, i.e.	V1	e1*00004*	1998-		390x370	0176	390x370	0182	---	---	---	---
DUCATI	916 Strada, Biposto	916	G846	1994-		335x305	0954	---	---	---	---	340x310	0955
DUCATI	916 SP Senna	ZDM 916...	EBE	1994-		335x305	0954	---	---	---	---	340x310	0955
DUCATI	916 SPS, 996 SPS	H1	EBE	2000	-	335x305	0954	---	---	---	---	340x310	0955
DUCATI	Monster (937)	1M	e3*00049 (VO)	2021	-	---	---	---	---	---	---	215x240	20688
DUCATI	Monster (937)	3M	e3*00051 (VO)	2021	-	---	---	---	---	---	---	215x240	20688
DUCATI	939 Hypermotard / -strada	BA	e49*00008 (VO)	2016	-	---	---	---	---	---	---	450x320	6492
DUCATI	959 Panigale	HA	e49*00003 (VO)	2016	-	---	---	---	---	---	---	370x250	7621
DUCATI	959 Panigale	HA	e49*00004 (VO)	2016	-	---	---	---	---	---	---	370x250	7621
DUCATI	959 Panigale	HB	e49*00005 (VO)	2016	-	---	---	---	---	---	---	370x250	7621
DUCATI	Multistrada 950	AA	e3*00001 (VO)	2017	-	---	---	605x335	7623	605x335	7624	440x295	7622
DUCATI	Multistrada 950	AA	e3*00002 (VO)	2017	2019	---	---	605x335	7623	605x335	7624	440x295	7622
DUCATI	Multistrada 950	AD	e49*00045 (VO)	2019	-	---	---	605x335	7623	605x335	7624	440x295	7622
DUCATI	996	H2	e1*00012	1998	-	335x305	0954	---	---	---	---	340x310	0955
DUCATI	998, 999	H2	e1*00012	2001	-	335x305	0954	---	---	---	---	340x310	0955
DUCATI	999, 999S	H4	e3*0147	2003	-	410x310	1347	450x310	1348	---	---	410x320	1349
DUCATI	999, S, R	H4	e3*0147	2003	-	---	---	---	---	---	---	420x330	2541
DUCATI	DS 1000 Multistrada	V5	e3*0142*	2005	-	390x370	0176	390x370	0182	---	---	---	---
DUCATI	DS 1200 Multistrada, S	A2	e3*0563*	2010	-	---	---	573x330	5250	---	---	390x290	6273
DUCATI	DS 1200 Multistrada, S	A3	e24*0139*	2013	-	---	---	580x405	6491	580x405	6505	430x290	6490
DUCATI	DS 1200 Multistrada, S	A3	e24*0139*	2015	-	---	---	605x335	7623	605x335	7624	440x295	7622
DUCATI	Multistrada 1200	AA	e3*00001 (VO)	2016	-	---	---	605x335	7623	605x335	7624	440x295	7622

Hersteller	Handelsbezeichnung	Fahrzeugtyp	ABE- Nr. / EG- BE	Baujahr		VS1		VS2		VS2.1, VS2.2, VS2.3, VS2.4		VS3	
				von	bis	STANDARD		TOURING		TOURING		RACING	
						HxB	Teile-Nr.	HxB	Teile-Nr.	HxB	Teile-Nr.	HxB	Teile-Nr.
DUCATI	Multistrada 1200	AA	e3*00002 (VO)	2016	-	---	---	605x335	7623	605x335	7624	440x295	7622
DUCATI	Multistrada 1260, S, Enduro	AC	e3*00010 (VO)	2018	2019	---	---	605x335	7623	605x335	7624	440x295	7622
DUCATI	Multistrada V4	1A	e9*11661	2021	-	---	---	630x430	20728	660x430	20733	390x365	20729
DUCATI	1000 SS	V5	e3*0142*	1998-		390x370	0176	---	---	---	---	---	---
DUCATI	1098, 1098 S	H7	e3*0436*	2008	-	---	---	---	---	---	---	435x330	4667
DUCATI	1098 R	H7	e3*0436*	2008	-	---	---	---	---	---	---	435x330	4667
DUCATI	Monster 1100	M5	e3*0497*	2008	-	160x220	5890	---	---	---	---	260x220	5650
DUCATI	Monster 1200 R	MA	e49*00006 (VO)	2016	-	---	---	---	---	---	---	270x190	8900
DUCATI	Monster 1200 R	MB	e49*00007 (VO)	2016	-	---	---	---	---	---	---	270x190	8900
DUCATI	Monster 1200 R	MA	e49*00013 (VO)	2016	-	---	---	---	---	---	---	270x190	8900
DUCATI	1198, S	H7	e3*0436*	2008	-	---	---	---	---	---	---	435x330	4667
DUCATI	955 Panigale V2	1H	e49*00021 (VO)	2020	-	---	---	---	---	---	---	400x275	9690
DUCATI	955 Panigale V2	1H	e49*00022 (VO)	2020	-	---	---	---	---	---	---	400x275	9690
DUCATI	1100 Panigale V4,V4S,V4R	DA	e49*00037 (VO)	2018	2020	---	---	---	---	---	---	400x275	9690
DUCATI	1100 Panigale V4,V4S,V4R	DA	e49*00037 (VO)	2018	2020	---	---	---	---	---	---	400x275	3759
DUCATI	1100 Panigale V4,V4S,V4R	DB	e49*00038 (VO)	2018	2020	---	---	---	---	---	---	400x275	9690
DUCATI	1100 Panigale V4,V4S,V4R	DB	e49*00038 (VO)	2018	2020	---	---	---	---	---	---	400x275	3759
DUCATI	1199 Panigale,superleggera	H8	e3*0586*	2012	-	---	---	---	---	---	---	400x250	5990
DUCATI	1299 Panigale	H8	e3*0586*	2015	-	---	---	---	---	---	---	370x250	7621
DUCATI	1299 Panigale, R, S, Anniversary	H9	e49*00001 (VO)	2015	-	---	---	---	---	---	---	370x250	7621
DUCATI	Supersport 937, S	VA	e49*00023 (VO)	2017	-	---	---	---	---	---	---	405x280	9434
DUCATI	Supersport 937, S	VB	e49*00032 (VO)	2019	-	---	---	---	---	---	---	405x280	9434
DUCATI	Supersport 937, S	VC	e49*00033 (VO)	2019	-	---	---	---	---	---	---	405x280	9434
DUCATI	Supersport 950 - / S	1V	e3*00042 (VO)	2021	-	---	---	---	---	---	---	405x280	9434
DUCATI	Supersport 950 - / S	3V	e3*00044 (VO)	2021	-	---	---	---	---	---	---	405x280	9434
HARLEY DAVIDSON	Pan America 1250	RA1	e4*00131 (VO)	2021	-			575x470	20840			365x375	20841
HONDA	CBF 125	JC 40	e13*0317*	2009	-	---	---	---	---	---	---	400x250	4930

S22_38182*26

Hersteller	Handelsbezeichnung	Fahrzeugtyp	ABE- Nr. / EG- BE	Baujahr		VS1		VS2		VS2.1, VS2.2, VS2.3, VS2.4		VS3	
				von	bis	STANDARD		TOURING		TOURING		RACING	
						HxB	Teile-Nr.	HxB	Teile-Nr.	HxB	Teile-Nr.	HxB	Teile-Nr.
HONDA	CBR 125 R	JC 34	e13*0004*	2004	-	275x270	1662	---	---	---	---	275x270	1663
HONDA	CBR 125 R	JC 39	e13*0185*	2007	-	---	---	---	---	---	---	270x250	4378
HONDA	CBR 125 R	JC 50	e13*0445*	2011	-	390x290	5640	---	---	---	---	420x280	X
HONDA	XL 125 Varadero	JC 32	e9*0053*	2001	-	380x340	1104	565x350	1105	---	---	---	---
HONDA	XL 125 V Varadero	JC 32	e9*0053*	2007	-	---	---	370x320	4379	---	---	---	---
HONDA	NS-1, NSR 50	DC01	EBE	97-		320x335	0060	---	---	---	---	220x340	1085
HONDA	NSR 125	JC 22	K353	97-		320x335	0060	---	---	---	---	220x340	1085
HONDA	CBR 250R, RA	MC41	e13*0457*	2011	-	390x325	5642	---	---	---	---	420x340	5643
HONDA	CBR 300R, RA	NC51	e13*0673*	2014	-							315x240	7228
HONDA	CB 500 S	PC 32	H418	98-		280x310	0740	435x290	0673	---	---	---	---
HONDA	CB 500 X	PC 46	e13*0622*	2013	-	---	---	485x350	6480	485x350	6992	---	---
HONDA	CB 500 X, XA	PC 46	e13*0622*	2015	-	---	---	520x310	8901	520x310	8902	---	---
HONDA	CB 500 XA	PC 59	e13*00093 (VO)	2017	-	---	---	520x310	8901	520x310	8902	---	---
HONDA	CB 500 XA	PC 64	e13*00093 (VO)	2019	-	---	---	520x310	8901	520x310	8902	---	---
HONDA	CBR 500 R, RA	PC 44	e13*0602*	2013	-	---	---	---	---	---	---	315x285	6479
HONDA	CBR 500 R, RA	PC 44	e13*0602*	2015	-	---	---	---	---	---	---	330x275	8903
HONDA	CBR 500 R, RA	PC 57	e13*00054 (VO)	2017	-	---	---	---	---	---	---	330x275	8903
HONDA	CBR 500 R, RA	PC 62	e13*00507 (VO)	2019	-	---	---	---	---	---	---	350x265	3613
HONDA	CB 600 F Hornet S	PC 34	K016	98-		285x340	0999	380x350	0292	---	---	305x355	1051
HONDA	CB 600 F Hornet S	PC 34	e13*0020*	2000	-	285x340	0999	380x350	0292	---	---	305x355	1051
HONDA	CB 600 F Hornet S	PC 36	e3*0101*	2001	-	285x340	0999	380x350	0292	---	---	305x355	1051
HONDA	CBF 600 S	PC 38	e3*0231*	2004	-	400x350	1659	500x350	1661	345x465	5898	400x350	1660
HONDA	CBF 600 S	PC 43	e3*0490*	2008	-	400x350	1659	500x350	1661	345x465	5898	400x350	1660
HONDA	CBR 600 F	PC 19	E515		90	---	---	350x330	0209	---	---	---	---
HONDA	CBR 600 F	PC 23	E978		90	---	---	350x330	0209	---	---	---	---
HONDA	CBR 600 F	PC 25	F648	91-		260x405	0812	320x415	0760	---	---	320x420	1115
HONDA	CBR 600 F	PC 31	H002	95-		315x375	0273	380x375	0275	---	---	---	---
HONDA	CBR 600 F	PC 35	K294	99-		395x395	0577	430x395	0605	---	---	440x375	0042
HONDA	CBR 600 F	PC 41	e3*0454	2011	-	340x350	5636	---	---	---	---	370x300	5637
HONDA	CBR 600 FI , Sport	PC 35	e4*0101*	2001	-	400x385	0827	470x360	0828	---	---	400x370	0861
HONDA	CBR 600 RR	PC 37	e4*0190	2003	-	330x335	1330	380x335	1331	---	---	300x320	1332
HONDA	CBR 600 RR	PC 37	e4*0190	2005	-	290x330	2051	---	---	---	---	280x320	2058
HONDA	CBR 600 RR	PC 40	e4*1247*	2007	-	350x320	4355	---	---	---	---	340x315	4356
HONDA	CBR 600 RR, RA	PC 40	e4*1247*	2013	-	---	---	---	---	---	---	240x280	6478

Hersteller	Handelsbezeichnung	Fahrzeugtyp	ABE- Nr. / EG- BE	Baujahr		VS1		VS2		VS2.1, VS2.2, VS2.3, VS2.4		VS3	
				von	bis	STANDARD		TOURING		TOURING		RACING	
						HxB	Teile-Nr.	HxB	Teile-Nr.	HxB	Teile-Nr.	HxB	Teile-Nr.
HONDA	CBR 650 F	RC 74	e13*0677*	2014	-	---	---	435x375	7595	435x375	7601	355x310	7003
HONDA	CBR 650 F	RC 96	e13*00097 (VO)	2017	-	---	---	435x375	7595	435x375	7601	355x310	7003
HONDA	CBR 650 RA	RH 01	e13*00517 (VO)	2019		---	---	---	---	---	---	335x285	3568
HONDA	CBR 650 RA	RH 01	e13*00518 (VO)	2019		---	---	---	---	---	---	335x285	3568
HONDA	CBR 650 RA	RH 07	e4*00122 (VO)	2020	-	---	---	---	---	---	---	335x285	3568
HONDA	CBR 650 RA	RH 07	e4*00123 (VO)	2020	-	---	---	---	---	---	---	335x285	3568
HONDA	XLV 600 Transalp	PD 06	E512		93	335x415	0898	455x420	0043	---	---	---	---
HONDA	XLV 600 Transalp	PD 06, PD10	H686	1994		330x390	0224	455x390	0268	---	---	---	---
HONDA	XL 650 V Transalp	RD 10	e3*0017*	2000	-	375x370	0119	530x380	0377	---	---	---	---
HONDA	XL 650 V Transalp	RD 11	e9*0077*	2002	-	375x370	0119	530x380	0377	---	---	---	---
HONDA	NX 650 Dominator	RD 02	E851	1992		---	---	335x330	0338	---	---	---	---
HONDA	NT 650 V Deauville	RC 47	K027	1998		---	---	550x380	0414	---	---	---	---
HONDA	CTX 700	RC 68	e9*2994*	2014	-	---	---	510x580	7227	---	---	---	---
HONDA	NSA 700 A (DN-01)	RC 55	e4*1904*	2008	-	---	---	---	---	---	---	650x400	4928
HONDA	NT 700 V Deauville	RC 52	e9*0069*	2006	-	400x465	4099	530x510	4100	530x510	5901	---	---
HONDA	NC 700 S	RC 61	e4*2824*	2012	-	---	---	430x320	6361	430x320	6001	340x295	5991
HONDA	NC 700 X	RC 63	e4*2789*	2012	-	---	---	480x420	5992	480x420	6002	---	---
HONDA	NC 750 S	RC 70	e4*3021*	2014	-	---	---	430x320	6361	430x320	6001	340x295	5991
HONDA	NC 750 SA/ SD	RC 88	e4*00011*	2016	-	---	---	430x320	6361	430x320	6001	340x295	5991
HONDA	NC 750 X	RC 72	e4*3022*	2014	-	---	---	480x420	5992	480x420	6002	---	---
HONDA	NC 750 XA/ XD	RC 90	e4*00007*	2016	-	---	---	520x325	8910	520x325	8911	300x270	8909
HONDA	NC 750 XA/ XD	RH 09	e6*00066 (VO)	2021	-	---	---	540x330	20752	545x330	20753	380X295	20773
HONDA	NC 750 XA/ XD	RH 09	e6*00067 (VO)	2021	-	---	---	540x330	20752	545x330	20753	380X295	20773
HONDA	XL 700 V Transalp	RD 13	e9*0223*	2008	-	---	---	500x310	4624	---	---	---	---
HONDA	XL 700 V Transalp	RD 15	e9*426*	2010	-	---	---	500x310	4624	---	---	---	---
HONDA	XRV 750 Africa Twin	RD 04	F371	1990	-	410x350	0628	510x365	0157	---	---	---	---
HONDA	XRV 750 Africa Twin	RD 07	G317	1993	-	420x340	0142	500x350	0144	---	---	---	---
HONDA	XRV 750 Africa Twin	RD 07	G317	1996	-	310x350	0136	380x370	0140	---	---	---	---
HONDA	VFR 750 F	RC 36	E840	1990	-	435x420	0825	335x400	0438	---	---	---	---
HONDA	VFR 750 F	RC 36	F372	1994	-	325x420	0161	440x375	0177	---	---	---	---
HONDA	VFR 800	RC 46	K011	1998	-	415x370	0688	480x370	0675	---	---	405x380	0034
HONDA	VFR 800 VTEC	RC 46	e1*0132*	2002	-	475x390	1095	510x390	1096	---	---	390x390	1097
HONDA	VFR 800 X Crossrunner	RC 60	e4*2673	2011	-	---	---	480x470	5639	---	---	---	---
HONDA	VFR 800 X Crossrunner	RC 80	e1*3110*	2015	-	---	---	570x435	7626	570x435	7627	---	---

Hersteller	Handelsbezeichnung	Fahrzeugtyp	ABE- Nr. / EG- BE	Baujahr		VS1		VS2		VS2.1, VS2.2, VS2.3, VS2.4		VS3	
				von	bis	STANDARD		TOURING		TOURING		RACING	
						HxB	Teile-Nr.	HxB	Teile-Nr.	HxB	Teile-Nr.	HxB	Teile-Nr.
HONDA	VFR 800 X Crossrunner	RC 94	e4*00041 (VO)	2017	-	---	---	570X435	9444	570X435	9445	---	---
HONDA	CBR 900 RR	SC 28	G034		93	300x400	0128	370x400	0134	---	---	---	---
HONDA	CBR 900 RR	SC 28 / SC 33	G034/ H294	1994	-	315x420	0124	360x420	0125	---	---	370x410	0012
HONDA	CBR 900 RR	SC 33	H294	1998	-	375x380	0738	375x390	0674	---	---	370x400	0949
HONDA	CBR 900 RR	SC 44	e13*0019*	2000	-	435x340	0100	450x390	0101	---	---	390x390	0201
HONDA	CBR 900 RR	SC 50	e13*0052*	2002	-	325x380	1098	365x370	1099	---	---	320x400	1100
HONDA	CBR 1000 F	SC 21	E513		88	345x310	0115	425x380	0117	---	---	---	---
HONDA	CBR 1000 F	SC 24	F143	1989	-	360x415	0007	385x415	0010	---	---	---	---
HONDA	CBR 1000 F	SC 24	F143	1993	-	360x415	0018	425x415	0020	---	---	---	---
HONDA	CBR 1000 RR	SC 57	e4*0269*	2004	-	365x355	1664	---	---	---	---	370x330	1665
HONDA	CBR 1000 RR	SC 59	e4*1726*	2008	-	290x300	4622	---	---	---	---	290x285	4623
HONDA	CBR 1000 RR	SC 59	e4*1726*	2012	-	---	---	---	---	---	---	340x300	5994
HONDA	CBR 1000 RA, S1	SC 77	e4*00054 (VO)	2017	-	---	---	---	---	---	---	330x245	9407
HONDA	CBR 1000 ST, SP	SC 82	e4*00126 (VO)	2020	-							335x270	20313
HONDA	CBR 1000 ST, SP	SC 82	e4*00126 (VO)	2020	-							335x270	20314
HONDA	CBF 1000	SC 58	e3*0373*	2006	-	400x350	1659	500x350	1661	---	---	400x350	1660
HONDA	CBF 1000/F	SC 64	e4*2395*	2010	-	390x325	5642	470x340	5252	470x340	5899	420x340	5643
HONDA	CRF 1000, A,D (Africa Twin)	SD 04	e4*3185*	2016	-	---	---	590x355	8905	590x355	8906	415x290	8904
HONDA	CRF 1000, A,A2,D,D2	SD 06	e4*00033 (VO)	2017	-	---	---	590x355	8905	590x355	8906	415x290	8904
HONDA	CRF 1100 A, D (Africa Twin)	SD 08	e4*00118 (VO)	2020	-	---	---	480x320	3818	480x320	3819	---	---
HONDA	CRF 1100 (Afr. Tw. Advent.)	SD 08	e4*00118 (VO)	2020	-	---	---	---	---	---	---	450x295	3820
HONDA	CRF1000 A2, A4, D2, D4 (Afr.Twin)	SD 09	e4*00115 (VO)	2020	-	---	---	480x320	3818	505x320	3819	---	---
HONDA	CRF 1100 (Afr. Tw. Advent.)	SD 09	e4*00115 (VO)	2020	-	---	---	---	---	---	---	450x295	3820
HONDA	XL 1000 Varadero	SD 01	e4*0009*	1998	2002	---	---	615x545	0361	---	---	---	---
HONDA	XL 1000 Varadero	SD 02	e9*0059*	2001	2002	---	---	615x545	0361	---	---	---	---
HONDA	XL 1000 Varadero	SD 02	e9*0059*	2003	-	500x380	1634	600x380	1635	600x380	5903	---	---
HONDA	XL 1000 Varadero	SD 03	e9*0421*	2010	-	---	---	600x380	1635	600x380	5903		
HONDA	VTR 1000	SC 36	H687	1997	-	380x330	0529	320x430	0505	---	---	380x345	0964
HONDA	VTR 1000 SP-1	SC 45	e4*0061*	2000	-	310x320	0214	---	---	---	---	300x315	0340

S22 38182*26

Hersteller	Handelsbezeichnung	Fahrzeugtyp	ABE- Nr. / EG- BE	Baujahr		VS1		VS2		VS2.1, VS2.2, VS2.3, VS2.4		VS3	
				von	bis	STANDARD		TOURING		TOURING		RACING	
						HxB	Teile-Nr.	HxB	Teile-Nr.	HxB	Teile-Nr.	HxB	Teile-Nr.
HONDA	VTR 1000 SP-2	SC 45	e4*0061*	2002	-	310x320	0214	---	---	---	---	300x315	0340
HONDA	CBR 1100 XX	SC 35	H541	1996	-	445x440	1125	470x415	0028	---	---	450x445	0283
HONDA	CBR 1100 XX	SC 35	e13*0043*	2002	-	445x440	1125	470x415	0028	---	---	450x445	0283
HONDA	ST 1100 Pan European	SC 26	F440	1990	-	---	---	475x405	0037	---	---	---	---
HONDA	ST 1100 Pan European	SC 26	F440	1990	-	---	---	540x520	0063	---	---	---	---
HONDA	ST 1100 Pan European	SC 26	F440	1990	-	---	---	560x520	0190	560x520	5902	---	---
HONDA	ST 1300 Pan European	SC 51	e1*0147*	2002	-	---	---	590x630	5995	590x630	7591	---	---
HONDA	VFR 800 F	RC 79	e4*3054*	2014	-	---	---	540x400	7007	540x400	7008	435X340	7598
HONDA	VFR 800 F	RC 93	e4*00042 (VO)	2017	-	---	---	540x400	7007	540x400	7008	435X340	7598
HONDA	VFR 1200 F	SC 63	e4*2383*	2010	-	390x290	5640	---	---	---	---	450x410	5251
HONDA	VFR 1200 X Crosstourer	SC 70	e4*2701*	2012	-	---	---	510x470	5993	510x470	6003	---	---
HONDA	VFR 1200 X,XL,XD,XDL Cross.	SC 76	e4*00012 (VO)	2016	-	---	---	510x470	8907	510x470	8908	---	---
HONDA	CB 1300 S	SC 54	e4*0187*	2003	-	---	---	470x320	4098	470x320	5900	---	---
HONDA	CTX 1300	SC 74	e4*3047*	2014	-	---	---	580X570	7005	580X570	7006	---	---
HONDA	ADV 750	RC 95	e4*00060 (VO)	2017	-	---	---	655x430	9709	655x430	9712	---	---
HONDA			e4*00074 (VO)	2018	-	---	---	655x430	9709	655x430	9712	---	---
HONDA	X-ADV 750	RH 10	e6*00057 (VO)	2020	-	---	---	710x380	20585	710x380	20586	540X365	20584
HONDA			e6*00058 (VO)	2020	-	---	---	710x380	20585	710x380	20586	540X365	20584
HYOSUNG	EXIV 125		EBE	2012	-	---	---	---	---	---	---	280x285	5996
HYOSUNG	GT 125, 250	GT	e9*0114*	2003	-	---	---	---	---	---	---	370x365	4184
HYOSUNG	GT 650 S, R	GT650	e9*0002*	2004	-	---	---	---	---	---	---	370x365	4184
HYOSUNG	GT 650i R Sport	GT650	e9*0002*	2009	-	340x350	5636	---	---	---	---	385x355	6716
KAWASAKI	Ninja 125	BX125A	e1*00106 (VO)	2019	-	---	---	---	---	---	---	295x285	3539
KAWASAKI	ZX 250 R Ninja	EX 250 K	e1*0351*	2008	-	---	---	---	---	---	---	340x325	4626
KAWASAKI	Ninja 250 SL	BX 250 A	e1*0639*	2015	-	---	---	---	---	---	---	345x270	7630
KAWASAKI	Ninja 300 ABS	EX 300 A	e1*0572*	2013	-	---	---	---	---	---	---	415x355	6463
KAWASAKI	Ninja 400	EX 400 G	e1*00067 (VO)	2018	-	---	---	---	---	---	---	400x335	9976
KAWASAKI	Versys-X 300	LE 300 C	e4*00049 (VO)	2017	-	---	---	520x310	9710	520x310	9713	---	---
KAWASAKI	ZXR 400	ZX 400 L	F669	1991	-	320x400	0038	435x380	0040	---	---	420x425	1521
KAWASAKI	KLE 500	LE 500 A	F670	1994	-	---	---	430x335	0767	---	---	---	---
KAWASAKI	KLE 500	LE 500 A	F670	1995	-	705x580	0302	435x335	0463	---	---	---	---

Hersteller	Handelsbezeichnung	Fahrzeugtyp	ABE- Nr. / EG- BE	Baujahr		VS1		VS2		VS2.1, VS2.2, VS2.3, VS2.4		VS3	
				von	bis	STANDARD		TOURING		TOURING		RACING	
						HxB	Teile-Nr.	HxB	Teile-Nr.	HxB	Teile-Nr.	HxB	Teile-Nr.
KAWASAKI	KLE 500	LE 500 A	e1*00074*	2000	-	705x580	0302	435x335	0463	---	---	---	---
KAWASAKI	KLE 500	LE 500 A	e1*00074*	2005	-	---	---	---	---	---	---	430x270	1520
KAWASAKI	GPZ 500 S	EX 500 A	E444		93	410x360	0679	425x300	0710	---	---	---	---
KAWASAKI	GPZ 500 S	EX 500 D	G587	1994	-	390x360	0078	420x370	0080	---	---	---	---
KAWASAKI	GPZ 600 R	ZX 600 A	D753	1987	-	330x330	0047	360x330	0081	---	---	---	---
KAWASAKI	GPX 600 R	ZX 600 A	D753		-	340x295	0083	435x300	0087	---	---	---	---
KAWASAKI	ZZR 600	ZX 600 D	F382	1990	-	370x330	0707	425x330	0712	---	---	---	---
KAWASAKI	ZZR 600	ZX 600 E	G202	1993	-	370x360	0206	420x380	0207	---	---	---	---
KAWASAKI	ZX - 6 R Ninja	ZX 600 F	G937	1995	-	325x345	0093	435x340	0094	---	---	---	---
KAWASAKI	ZX - 6 R Ninja	ZX 600 G	H967	98-	-	365x325	0753	410x400	0779	---	---	425x390	0299
KAWASAKI	ZX - 6 R Ninja	ZX 600 J	e4*0042*	2000	-	405x320	0484	490x340	0493	---	---	430x385	0514
KAWASAKI	ZX - 6 R Ninja	ZX 636 A	e1*00141*	2002	-	430x385	1333	410x430	1334	---	---	340x430	1335
KAWASAKI	ZX - 6 R Ninja	ZX 636 B	e4*0180*	2003	-	430x385	1333	410x430	1334	---	---	340x430	1335
KAWASAKI	ZX - 6 R Ninja	ZX 636 C	e1*0229*	2005	-	360x360	4052	---	---	---	---	400x360	4053
KAWASAKI	ZX - 6 R Ninja	ZX 600 P	e4*1274*	2007	-	280x430	2065	---	---	---	---	400x360	4053
KAWASAKI	ZX - 6 R Ninja	ZX 600 R	e4*2077*	2009	-	370x350	4627	---	---	---	---	380x360	4625
KAWASAKI	ZX - 6 R Ninja	ZX 600 R	e4*2077*	2009	-	400x360	5117	---	---	---	---	345x345	5118
KAWASAKI	ZX - 6 RR Ninja	ZX 600 N	e4*0364*	2009	-	400x360	5117	---	---	---	---	345x345	5118
KAWASAKI	ZX- 6R 636	ZX 636 E	e1*0571*	2013	-	---	---	---	---	---	---	340x350	6482
KAWASAKI	ZX- 6R 636	ZX636 G	e1*00104 (VO)	2019	-	---	---	---	---	---	---	350x350	3177
KAWASAKI						---	---	---	---	---	---	370x350	3629
KAWASAKI	ER-6F	EX 650 A	e1*0269*	2005	-	520x355	4105	590x355	4107	---	---	530x350	4106
KAWASAKI	ER-6F	EX 650 C	e1*0417*	2009	-	---	---	---	---	---	---	460x330	4931
KAWASAKI	ER-6F	EX 650 E	e1*0538*	2012	-	---	---	---	---	340x295	6004	540x450	5998
KAWASAKI	Ninja 650, ABS	EX650K	e1*00039 (VO)	2017	-	---	---	---	---	---	---	450x310	9711
KAWASAKI	Ninja 650, ABS	EX650KA2	e1*00040 (VO)	2017	-	---	---	---	---	---	---	450x310	9711
KAWASAKI	Ninja 650	EX650M	e1*00182 (VO)	2020	-	---	---	---	---	---	---	455x385	3880
KAWASAKI	Ninja 650	EX650MA2	e1*00183 (VO)	2020	-	---	---	---	---	---	---	485x385	3881
KAWASAKI	VERSYS 650	LE 650 A	e1*0305*	2006	-	---	---	370x340	4360	---	---	---	---
KAWASAKI	VERSYS 650	LE 650 C	e1*0462*	2010	-	---	---	400x315	5255	400x315	5905	---	---
KAWASAKI	VERSYS 650	LE 650 E (E,F)	e1*0653*	2015	-	---	---	490x450	5999	500x500	6005	---	---
KAWASAKI	VERSYS 650	LE 650 E	e1*00027 (VO)	2017	-	---	---	490x450	9421	---	---	---	---
KAWASAKI	VERSYS 650	LE650 EA2	e1*00028 (VO)	2017	-	---	---	490x450	9421	---	---	---	---
KAWASAKI	VERSYS 1000	LZT 00 A	e1*0540*	2012	-	---	---	490x450	5999	500x500	6005	---	---

Hersteller	Handelsbezeichnung	Fahrzeugtyp	ABE- Nr. / EG- BE	Baujahr		VS1		VS2		VS2.1, VS2.2, VS2.3, VS2.4		VS3	
				von	bis	STANDARD		TOURING		TOURING		RACING	
						HxB	Teile-Nr.	HxB	Teile-Nr.	HxB	Teile-Nr.	HxB	Teile-Nr.
KAWASAKI	VERSYS 1000	LZT 00 B	e4*3111*	2015	-	---	---	490x450	5999	500x500	6005	---	---
KAWASAKI	VERSYS 1000	LZT 00 B	e4*00029 (VO)	2017	-	---	---	490x450	9421	---	---	---	---
KAWASAKI	VERSYS 1000	LZT 00 C	e4*00086 (VO)	2018	-	---	---	490x450	9421	---	---	---	---
KAWASAKI	VERSYS 1000 SE, TOURER, GRAND	LZT 00 C	e4*00086 (VO)	2018	-	---	---	555x487	3640	597x487	3731	---	---
KAWASAKI	Z 750	ZR 750 J	e1*0197*	2004	-	---	---	---	---	---	---	430x290	1658
KAWASAKI	Z 750 S	ZR 750 J	e1*0197*	2005	-	---	---	450x300	2089	---	---	385x300	2087
KAWASAKI	Z 750 R	ZR 750 N	e1*0487*	2011	-	---	---	---	---	---	---	365x290	5638
KAWASAKI	GPZ 750 R	ZX 750 G	D608	85-	-	385x340	0097	430x345	0098	---	---	---	---
KAWASAKI	ZR - 7S	ZR 750 F	e1*00023*	2001	-	470x380	0056	510x375	0123	---	---	458x400	1312
KAWASAKI	ZXR 750	ZX 750 H	F102	89-	-	360x430	0106	440x460	0108	---	---	---	---
KAWASAKI	ZXR 750 (R)	ZX 750 J	F671	91-	-	335x395	0109	445x380	0114	---	---	---	---
KAWASAKI	ZXR 750	ZX 750 L	G154	93-	-	370x425	0113	410x430	0111	---	---	---	---
KAWASAKI	ZX - 7 R	ZX 750 P	H202	96-	-	430x365	0335	455x365	0647	---	---	430x385	0314
KAWASAKI	GPZ 900 R	ZX 900 A	D363	84-	-	385x340	0097	430x345	0098	---	---	---	---
KAWASAKI	ZX - 9 R Ninja	ZX 900 B	G588	94-	-	365x430	0344	430x430	0349	---	---	---	---
KAWASAKI	ZX - 9 R Ninja	ZX 900 C	H884	98-	-	350x430	0705	430x430	0739	---	---	440x430	0301
KAWASAKI	ZX - 9 R Ninja	ZX 900 E	e1*00054*	2000	-	340x395	0515	490x350	0530	---	---	390x350	0565
KAWASAKI	KLV 1000	WVBS	e4*0142*	2004	-	390x380	2158	515x420	1880	---	---	---	---
KAWASAKI	ZX- 10	ZXT00B	E795	88-	-	---	---	480x380	0351	---	---	---	---
KAWASAKI	ZX- 10 R Ninja	ZXT00C	e4*0246*	2004	-	380x290	1656	---	---	---	---	380x300	1657
KAWASAKI	ZX- 10 R Ninja	ZXT00D	e1*0270*	2006	-	360x360	4052	---	---	---	---	400x360	4053
KAWASAKI	ZX- 10 R Ninja	ZXT00E	e1*0350*	2008	-	400x360	5117	---	---	---	---	340x270	5118
KAWASAKI	ZX- 10 R Ninja	ZXT00J	e4*2548*	2011	-	405x390	5602	470x340	5252	---	---	450x350	5603
KAWASAKI	ZX- 10 R Ninja	ZXT00S	e4*00006 (VO)	2016	-	---	---	---	---	---	---	350x300	8912
KAWASAKI	ZX-10RR Ninja	ZXT00S	e4*00006 (VO)	2017	-	---	---	---	---	---	---	350x300	8912
KAWASAKI	ZX-10RR Ninja	ZXT00S	e4*00006 (VO)	2017	-	---	---	---	---	---	---	360x325	9849
KAWASAKI	ZX-10R SE Ninja	ZXT02C	e4*00077 (VO)	2018	-	---	---	---	---	---	---	350x300	8912
KAWASAKI	ZX-10R SE Ninja	ZXT02C	e4*00077 (VO)	2018	-	---	---	---	---	---	---	360x325	9849
KAWASAKI	ZX-10R SE Ninja	ZXT02E	e4*00091 (VO)	2019	-	---	---	---	---	---	---	350x300	8912
KAWASAKI	ZX-10R SE Ninja	ZXT02E	e4*00091 (VO)	2019	-	---	---	---	---	---	---	360x325	9849
KAWASAKI	ZX-10R , RR	ZXT02L	e4*00141 (VO)	2021	-	---	---	---	---	---	---	320x285	20540
KAWASAKI	ZX-10R , RR	ZXT02L	e4*00141 (VO)	2021	-	---	---	---	---	---	---	320x285	20541
KAWASAKI	Ninja H2	ZXT00N	e4*3111*	2015	-	---	---	---	---	---	---	330x330	7631

Hersteller	Handelsbezeichnung	Fahrzeugtyp	ABE- Nr. / EG- BE	Baujahr		VS1		VS2		VS2.1, VS2.2, VS2.3, VS2.4		VS3	
				von	bis	STANDARD		TOURING		TOURING		RACING	
						HxB	Teile-Nr.	HxB	Teile-Nr.	HxB	Teile-Nr.	HxB	Teile-Nr.
KAWASAKI	Ninja H2 SX	ZXT02A	e4*00073 (VO)	2018	-	---	---	---	---	---	---	400x390	9704
KAWASAKI	Ninja 1000 SX	ZXT02K	e4*00116 (VO)	2020	-	---	---	---	---	---	---	480x420	20471
KAWASAKI	Z 1000	ZRT00A	e1*0172*	2003	-	260x265	1336	---	---	---	---	430x270	1520
KAWASAKI	Z 1000	ZRT00B	e4*1275*	2007	-	---	---	---	---	---	---	370x295	4361
KAWASAKI	Z 1000	ZRT00D	e4*2374*	2010	-	400x360	5117	---	---	---	---	---	---
KAWASAKI	Z 1000 SX	ZXT00G	e1*0486*	2011	-	---	---	---	---	---	---	505x400	5606
KAWASAKI	Z 1000 SX	ZXT00L	e1*0611*	2014	-	---	---	---	---	---	---	505x400	5606
KAWASAKI	Z 1000 SX	ZXT00W	e4*00034 (VO)	2017	-	---	---	---	---	---	---	470x380	9408
KAWASAKI	GPZ 1100	ZXT 10 E	G938	95-	-	330x415	0368	445x410	0412	---	---	---	---
KAWASAKI	ZZR 1100	ZXT 10 C	F381	92	-	465x370	0708	490x370	0461	---	---	---	---
KAWASAKI	ZZR 1100	ZXT 10 D	G203	93-	-	450x390	0441	495x405	0039	---	---	---	---
KAWASAKI	ZRX 1100	ZRT 10 C	H619	97-	-	245x310	0396	365x325	0426	---	---	---	---
KAWASAKI	ZZR 1200	ZXT 20 C	e1*00142*	2002	-	420x410	1101	485x430	1102	---	---	440x420	1103
KAWASAKI	ZRX 1200 R	ZRT 20 A	e4*0106*	97-	-	245x310	0396	365x325	0426	---	---	---	---
KAWASAKI	ZRX 1200 S	ZRT 20 A	e4*0106*	2001	-	365x325	0059	560x405	0084	---	---	500x420	1093
KAWASAKI	ZX -12 R Ninja	ZXT 20 A	e1*00065*	2000	-	420x375	0369	480x375	0422	---	---	410x390	0451
KAWASAKI	ZX -12 R Ninja	ZXT 20 A	e1*00065*	2002	-	390x380	1121	455x370	1122	---	---	385x370	1123
KAWASAKI	ZZR 1400	ZXT 40 A	e4*0912*	2006	-	390x375	4056	---	---	---	---	440x360	4057
KAWASAKI	ZZR 1400	ZXT 40 C	e4*1560*	2008	-	390x375	4056	---	---	---	---	440x360	4057
KAWASAKI	ZZR 1400	ZXT 40 E	e4*2810*	2012	-	390x375	4056	---	---	---	---	440x360	4057
KAWASAKI	ZZR 1400 / ZX-14R	ZXT 40 H	e4*00003 (VO)	2016	-	390x375	4056	---	---	---	---	440x360	4057
KAWASAKI	GTR 1400	ZGT 40 A	e1*0310*	2007	-	---	---	680x570	4619	680x570	5904	---	---
KAWASAKI	GTR 1400	ZGT 40 C	e1*0442*	2009	-	---	---	680x570	4619	680x570	5904	---	---
KAWASAKI	GTR 1400	ZGT 40 E	e1*0647*	2015	-	---	---	705x580	7628	705x580	7629	---	---
KTM	KTM 125 DUKE	KTM IS DUKE	e1*0512*	2011	-	---	---	---	---	---	---	250x210	6275
KTM	KTM 200 DUKE	KTM IS DUKE	e1*0512*	2011	-	---	---	---	---	---	---	250x210	6275
KTM	KTM 390 DUKE	KTM IS DUKE	e1*0512*	2013	-	---	---	---	---	---	---	250x210	6275
KTM	250 Adventure	KTM IS Adventure	e1*00209 (VO)	2020	-	---	---	500x330	20414	520x330	20415	---	---
KTM	390 Adventure	KTM IS Adventure	e1*00209 (VO)	2020	-	---	---	500x330	20414	520x330	20415	---	---
KTM	125 / 250 / 390 RC	KTM IS RC	e1*0646*	2014	-	---	---	---	---	---	---	490x420	7004
KTM	690 Duke	KTM Duke	e1*0353*	2008	-	---	---	---	---	---	---	290x290	4941
KTM	790 Adventure	KTM 790 Adventure	e1*00148 (VO)	2019	-	---	---	525x385	3587	545x385	3588	366x348	3738
KTM	790 Adventure	KTM 790 Adventure	e1*00149 (VO)	2019	-	---	---	525x385	3587	545x385	3588	366x348	3738

Hersteller	Handelsbezeichnung	Fahrzeugtyp	ABE- Nr. / EG- BE	Baujahr		VS1		VS2		VS2.1, VS2.2, VS2.3, VS2.4		VS3	
				von	bis	STANDARD		TOURING		TOURING		RACING	
						HxB	Teile-Nr.	HxB	Teile-Nr.	HxB	Teile-Nr.	HxB	Teile-Nr.
KTM	790 Adventure R Rally	KTM 790 Adventure	e1*00149 (VO)	2020	-	---	---	525x385	3857	545x385	3588	366x348	3738
KTM	890 Adventure	KTM 790 Adventure	e1*00149 (VO)	2021	-	---	---	525x385	3857	545x385	3588	366x348	3738
KTM	990 Super Duke, R	KTM LC8 EFI	e1*0232*	2008	-	---	---	---	---	---	---	290x320	4942
KTM	990 Supermoto	KTM LC8 SM	e1*0249*	2009	-	---	---	300x260	4943	---	---	---	---
KTM	990 Supermoto T	KTM LC8 SM	e1*0249*	2011	-	---	---	510x400	6495	---	---	---	---
KTM	990 Adventure, R	KTM LC8	e1*0180*	2003	-	---	---	600x410	6204	---	---	---	---
KTM	1050 Adventure	KTM Adventure	e1*0596*	2015	-	---	---	510x420	6494	520x420	6506	315x310	6847
KTM	1090 Adventure, R	KTM Adventure	e1*00031 (VO)	2017	-	---	---	510x420	6494	520x420	6506	315x310	6847
KTM	1190 RC8	KTM RC8	e1*0379*	2009	-	---	---	---	---	---	---	370x350	4944
KTM	1190 Adventure	KTM Adventure	e1*0596*	2013	-	---	---	510x420	6494	520x420	6506	315x310	6847
KTM	1290 Super Adventure	KTM Adventure	e1*0596*	2015	-	---	---	510x420	6494	520x420	6506	315x310	6847
KTM	1290 Super Adventure	KTM V2 Adventure	e1*00274 (VO)	2021	-	---	---	440x465	20422	485x465	20586	270x415	20401
KTM	1290 Super Adventure	KTM V2 Adventure	e1*00274 (VO)	2021	-	---	---	440x465	20816	515x465	20817		
KTM	1290 Adventure T	KTM Adventure	e1*00031 (VO)	2017	-	---	---	510x420	6494	520x420	6506	315x310	6847
KTM	1290 Adventure R	KTM Adventure	e1*00031 (VO)	2017	-	---	---	490x420	9717	490x420	9714	290x310	9716
KTM	1290 Adventure S	KTM Adventure	e1*00031 (VO)	2017	-	---	---	490x420	9717	490x420	9714	290x310	9716
KTM	1290 Super Duke GT	KTM Superduke	e1*00001 (VO)	2016	-	---	---	600x440	8913	600x440	8914	---	---
KTM	1290 Super Duke GT	KTM Superduke	e1*00001 (VO)	2019	-	---	---	540x420	3564	565x420	3565	---	---
MV AGUSTA	F3 675	F3	e3*0587*	2010	-	---	---	---	---	---	---	330x325	5651
MV AGUSTA	F3 800	F3	e3*0587*	2013	-	---	---	---	---	---	---	330x325	5651
MV AGUSTA	F4 1000	F4	e3*0024*	2010	-	---	---	---	---	---	---	410x370	5256
MV AGUSTA	F4 RR	F6	e3*0564*	2013	-	---	---	---	---	---	---	---	---
MV AGUSTA	Stradale 800	S3	e3*0603*	2015	-	---	---	485x365	7634	485x365	7635	---	---
MV AGUSTA	Turismo Veloce 800, Lusso	T3	e3*0609*	2015	-	---	---	485x290	7017	485x290	7018	---	---
MV AGUSTA	Turismo Veloce 800, Lusso	T3	e9*11022 (VO)	2017	-	---	---	485x290	7017	485x290	7018	---	---
MOTORHISP.	RACING RX 50		EBE			350x395	0191	---	---	---	---	---	---
NAC. MOTOR	DERBI GPR50	GPRR	e9*0052*	98-	2001	320x340	0342	---	---	---	---	---	---
NAC. MOTOR	DERBI GPR50	GPRR	e9*0052*	2002	2004	---	---	---	---	---	---	280x330	1497
NAC. MOTOR	DERBI GPR50	GR	e9*0011*	2005	-	---	---	---	---	---	---	400x315	3962
NAC. MOTOR	DERBI GPR50	GR	e9*0011*	2009	-	---	---	---	---	---	---	385x225	5080

S22 38182*26

Hersteller	Handelsbezeichnung	Fahrzeugtyp	ABE- Nr. / EG- BE	Baujahr		VS1		VS2		VS2.1, VS2.2, VS2.3, VS2.4		VS3	
				von	bis	STANDARD		TOURING		TOURING		RACING	
						HxB	Teile-Nr.	HxB	Teile-Nr.	HxB	Teile-Nr.	HxB	Teile-Nr.
NAC. MOTOR	DERBI GPR125	GS	e9*0027*	2004	-	---	---	---	---	---	---	400x315	3962
NAC. MOTOR	DERBI GPR125	RG	e11*0752*	2009	-	---	---	---	---	---	---	385x225	5080
NAC. MOTOR	DERBI Predator	PRED	K191	99-		190x255	0365	---	---	---	---	---	---
PIAGGIO	Aprilia RS4 125	TW	e11*1159*	2011	-	---	---	---	---	---	---	365X270	4945
PIAGGIO	Aprilia Tuono 125	KC	e11*00231 (VO)	2017	-	---	---	---	---	---	---	320x270	7615
PIAGGIO	APRILIA RS 125	PY	e11*0383*	2006	-	---	---	---	---	---	---	400x300	4183
PIAGGIO	APRILIA Pegaso Strada	VD	e11*0170*	2005	-	---	---	410x350	2165	---	---	---	---
PIAGGIO	APRILIA Pegaso Trail 650	VD	e11*0170*	2006	-	---	---	410x350	2165	---	---	---	---
PIAGGIO	Aprilia Tuono 660	KS	e49*00059 (VO)	2021	-	---	---	---	---	---	---	350x285	20794
PIAGGIO	Aprilia Tuono 660	KV	e49*00060 (VO)	2021	-	---	---	---	---	---	---	350x285	20794
PIAGGIO	APRILIA RS 660	KS	e4*00059 (VO)	2020	-	---	---	---	---	---	---	330X255	20571
PIAGGIO	APRILIA Shiver 750	RA	e11*0619*	2010	-	---	---	---	---	---	---	350x330	5249
PIAGGIO	APRILIA Shiver 750 GT	RA	e11*0619*	2009	-	---	---	458x460	4946	458x460	5913	---	---
PIAGGIO	APRILIA Mana 850 GT	RC	e11*0663*	2009	-	---	---	500x340	5648	---	---	---	---
PIAGGIO	APRILIA RSV4 1000	RK	e11*0749*	2009	2015	---	---	---	---	---	---	365x270	4945
PIAGGIO	APRILIA RSV4 1000 RF, RR	RK	e11*0749*	2015	-	---	---	---	---	---	---	395x270	7614
PIAGGIO	APRILIA RSV4 1000 RF, RR	KE	e11*00253 (VO)	2017	-	---	---	---	---	---	---	395x270	7614
PIAGGIO	APRILIA RSV4 1000 RF, RR	KE1	e1* 00124 (VO)	2019	-	---	---	---	---	---	---	395x270	7614
PIAGGIO	APRILIA RSV4, Factory	KY	e49*00067 (VO)	2021	-	---	---	---	---	---	---	350X315	20771
PIAGGIO	APR. Tuono V4 1100 RR, Fact.	TY	e11*1156*	2015	-	---	---	---	---	---	---	320x270	7615
PIAGGIO	APR. Tuono V4 1100 RR	KG	e11*00255 (VO)	2017	-	---	---	---	---	---	---	320x270	7615
PIAGGIO	APR. Tuono V4 1100 RR, Fact.	KG1	e1* 00125 (VO)	2019	-	---	---	---	---	---	---	320x270	7615
PIAGGIO	APRILIA RSV 1000 V4R	RK	e11*0749*	2011	-	---	---	---	---	---	---	375x300	5647
PIAGGIO	APRILIA Caponord 1200	VK	e11*1642*	2013	-	---	---	590x440	6484	615x440	6502	---	---
PIAGGIO	APRILIA Caponord 1200 Rally	VK	e11*1642*	2015	-	---	---	590x440	6484	615x440	6502	---	---

Hersteller	Handelsbezeichnung	Fahrzeugtyp	ABE- Nr. / EG- BE	Baujahr		VS1		VS2		VS2.1, VS2.2, VS2.3, VS2.4		VS3	
				von	bis	STANDARD		TOURING		TOURING		RACING	
						HxB	Teile-Nr.	HxB	Teile-Nr.	HxB	Teile-Nr.	HxB	Teile-Nr.
RIEJU	RS3	RS3	EBE	2010	-	---	---	---	---	---	---	350x300	5257
RIEJU	RS1 EVOLUTION	RS1	EBE			375x340	0570	---	---	---	---	---	---
RIEJU	RS2	RS2	e11*00068*	2002	-	275x310	1595	---	---	---	---	280x310	1644
SUZUKI	GSX-R125	WDL0	e4*00070 (VO)	2017	-	---	---	---	---	---	---	340x305	9721
SUZUKI	GSX-R250	WDN0	e4*00059 (VO)	2017	-	---	---	---	---	---	---	365x300	9722
SUZUKI	DL250 V-Strom	WDS0	e4*00069 (VO)	2017	-			440x435	9606	440x435	9607	---	---
SUZUKI	GW 250 Inazuma	DC	e4*2840*	2015	-	---	---	---	---	---	---	410x390	7642
SUZUKI	GS 500 F	BK	e9*0116*	2003	-	336x355	1651	370x355	1653	---	---	340x370	1652
SUZUKI	GSF 600 S Bandit	GN 77 B	H008	96-		315x360	0445	385x355	0460	---	---	---	---
SUZUKI	GSF 600 S Bandit	WVA8	e4*0060*	2000	-	385x355	0697	475x375	0702	---	---	375x375	1116
SUZUKI	GSF 650 S Bandit	WVB5	e4*0359*	2005	-	375x375	2098	410x355	2125	---	---	340x360	2107
SUZUKI	GSF 650 S Bandit	WVCJ	e4*1342*	2007	-	375x375	2098	410x355	2125	---	---	340x360	2107
SUZUKI	GSX - 600 F	GN 72 B	E775	97	-	325x300	0678	370x320	0709	---	---	---	---
SUZUKI	GSX - 600 F	AJ	H928	98-		340x325	0806	400x325	0841	---	---	---	---
SUZUKI	GSX - R 600	AD	H583	96-		355x390	0693	420x340	0682	---	---	425x395	0015
SUZUKI	GSX - R 600	AD	H583	98-		440x400	0792	450x415	0798	---	---	430x395	0950
SUZUKI	GSX - R 600	WVBG	e4*0100*	2001	-	400x420	0053	465x405	0086	---	---	400x430	0189
SUZUKI	GSX - R 600	WVB2	e4*0253*	2004	-	350x330	1654	---	---	---	---	350x340	1655
SUZUKI	GSX - R 600	WVCE	e4*0849*	2006	-	340x340	4054	---	---	---	---	355x320	4055
SUZUKI	GSX - R 600	WVCV	e4*1756*	2008	-	355x320	4628	---	---	---	---	350x325	4629
SUZUKI	GSX - R 600	C3	e4*2578*	2011	-	350x325	5604	---	---	---	---	280x300	5605
SUZUKI	RF 600 R	GN 76 A	EBE	93-		410x390	0472	460x400	0640	---	---	---	---
SUZUKI	RF 600 R	GN 76 B	G319	93-		410x390	0472	460x400	0640	---	---	---	---
SUZUKI	DL 650 V- Strom	WVB1	e4*0233*	2004	-	390x380	1890	515x420	1880	515x420	5883	---	---
SUZUKI	DL 650 V- Strom	C7	e4*2680*	2012	-	---	---	540x430	5895	540x430	6253	---	---
SUZUKI	DL 650 XA V-Strom	C7	e4*2680*	2015	-	---	---	540x430	5895	540x430	6253	---	---
SUZUKI	DL 650 A, XA	WC70	e4*00035 (VO)	2017	-	---	---	540x430	9719	540x430	9440	---	---
SUZUKI	DL 650 AUE, XAUE	WC71	e4*00036 (VO)	2017	-	---	---	540x430	9719	540x430	9440	---	---
SUZUKI	GSF 650 S Bandit	WVCZ	e4*2163*	2009	-	410x380	5049	450x380	5050	450x380	5906	340x400	5079
SUZUKI	GSX 650 F	WVCJ	e4*1342*	2008	-	340x390	4632	450x395	4633	---	---	340x400	4665
SUZUKI	GSX-R 600	C3	e4*2578*	2011	-	350x325	5604	---	---	---	---	280x300	5605
SUZUKI	XF 650 Freewind	AC	H674	97	-	310x285	0413	400x300	0337	---	---	---	---
SUZUKI	XF 650 Freewind	AC	H674	2000	-	310x295	0685	375x315	0694	---	---	---	---

S22 38182*26

Hersteller	Handelsbezeichnung	Fahrzeugtyp	ABE- Nr. / EG- BE	Baujahr		VS1		VS2		VS2.1, VS2.2, VS2.3, VS2.4		VS3	
				von	bis	STANDARD		TOURING		TOURING		RACING	
						HxB	Teile-Nr.	HxB	Teile-Nr.	HxB	Teile-Nr.	HxB	Teile-Nr.
SUZUKI	SV 650 S	AV	K329	99	-	365x360	0711	425x350	0732	---	---	300x360	0843
SUZUKI	SV 650 S	WVBY	e4*0192*	2003	-	350x375	1344	450x385	1345	---	---	350x370	1346
SUZUKI	SV 650 N	WVBY	e4*0192*	2005	-	---	---	---	---	---	---	310x260	2093
SUZUKI	GSX 750 F	GR 78 A	F025		97	370x320	0055	400x280	0709	---	---	---	---
SUZUKI	GSX 750 F	AK	K222	98	-	340x325	0806	400x325	0841	---	---	---	---
SUZUKI	GSX 750 F	WVAK	e4*0171*	2003	-	340x325	8060	400x325	0841	---	---	---	---
SUZUKI	GSX R 750	GR 77 B	E776	88	-	290x450	0485	---	---	---	---	---	---
SUZUKI	GSX R 750	GR 7 AA	EBE		91	250x450	0491	---	---	---	---	---	---
SUZUKI	GSX R 750	GR 7 AB	F345		91	250x450	0491	---	---	---	---	---	---
SUZUKI	GSX- R 750 W	GR 7 BA	EBE	92	-	285x405	0630	395x405	0638	---	---	---	---
SUZUKI	GSX- R 750 W	GR 7 BB	F971	92	-	285x405	0630	395x405	0638	---	---	---	---
SUZUKI	GSX- R 750	GR 7 DB	H254	92	-	360x390	0620	425x400	0627	---	---	425x395	0015
SUZUKI	GSX- R 750	GR 7 DB	H254	98	-	440x400	0792	450x415	0798	---	---	430x395	0950
SUZUKI	GSX- R 750	WVBD	e4*0068	2000	-	400x420	0053	465x405	0086	---	---	400x430	0189
SUZUKI	GSX- R 750	WVB3	e4*0261*	2004	-	350x330	1654	---	---	---	---	350x340	1655
SUZUKI	GSX- R 750	WVCF	e4*0890*	2006	-	340x340	4054	---	---	---	---	355x320	4055
SUZUKI	GSX- R 750	WVCW	e4*1852*	2008	-	355x320	4628	---	---	---	---	350x325	4629
SUZUKI	GSX- R 750	C4	e4*2587*	2011	-	350x325	5604	---	---	---	---	280x300	5605
SUZUKI	GSR 750	C5	e4*2594*	2011	-	---	---	---	---	---	---	275x265	5646
SUZUKI	DR 800	SR 43 B	F723	1991	-	---	---	385x355	0492	---	---	---	---
SUZUKI	RF 900 R	GT 73 A	EBE	1993	-	410x390	0472	460x400	0640	---	---	---	---
SUZUKI	RF 900 R	GT 73 B	G616	1993	-	410x390	0472	460x400	0640	---	---	---	---
SUZUKI	DL 1000 V-Strom	WVBS	e4*0142*	2002	-	440x365	1136	600x375	1137	---	---	---	---
SUZUKI	DL 1000 V-Strom	WVBS	e4*0142*	2004	-	390x380	1890	515x420	1880	---	---	---	---
SUZUKI	DL 1000 V-Strom	DD	e4*3025*	2014	-	---	---	460x435	7229	460x435	7230	---	---
SUZUKI	DL 1000 V-Strom, XT	WDD0	e4*00053 (VO)	2017	-	---	---	460x435	7229	460x435	7230		
SUZUKI	DL 1050 V-Strom, XT	WEF0	e6*00036 (VO)	2020-		---	---	630x480	20411	660x480	20412		
SUZUKI	SV 1000 S	WVBX	e4*0191*	2003	-	350x375	1344	450x385	1345	---	---	350x370	1346
SUZUKI	SV 1000 S	WVBX	e4*0191*	2005	-	---	---	---	---	---	---	310x260	2093
SUZUKI	TL 1000 R	AM	H977	98	-	350x370	0459	470x325	0619	---	---	455x305	0054
SUZUKI	TL 1000 S	AG	H632	98	-	545x330	0429	600x330	0430	---	---	540x330	0284
SUZUKI	GSX- R 1000	WVBL	e4*0108*	2001	-	400x420	0053	465x405	0086	---	---	400x430	0189
SUZUKI	GSX- R 1000	WVBZ	e4*0193*	2003	-	400x430	1338	520x450	1339	---	---	400x470	1340
SUZUKI	GSX- R 1000	WVB6	e4*0375*	2005	-	320x300	2071	---	---	---	---	310x330	2072

Hersteller	Handelsbezeichnung	Fahrzeugtyp	ABE- Nr. / EG- BE	Baujahr		VS1		VS2		VS2.1, VS2.2, VS2.3, VS2.4		VS3	
				von	bis	STANDARD		TOURING		TOURING		RACING	
						HxB	Teile-Nr.	HxB	Teile-Nr.	HxB	Teile-Nr.	HxB	Teile-Nr.
SUZUKI	GSX- R 1000	WVCL	e4*1343*	2007	-	310x300	4362	---	---	---	---	320x330	4363
SUZUKI	GSX- R 1000	WVCY	e4*2132*	2009	-	370x330	4932	---	---	---	---	360x340	4933
SUZUKI	GSX- R 1000	WVCY	e4*2132*	2015	-	370x330	4932	---	---	---	---	360x340	4933
SUZUKI	GSX- R 1000	WVCY	e4*2132*	2016	-	---	---	---	---	---	---	360x340	4933
SUZUKI	GSX- R 1000 AL	WDM0	e4*00052 (VO)	2017	2019	---	---	---	---	---	---	310x275	9013
												288X285	3631
SUZUKI	GSX- S 1000 FA	DG	e4*3135*	2015	-	---	---	590x325	7640	590x325	7641	330x280	7639
SUZUKI	GSX-S 1000 FA	WDG0	e4*00051 (VO)	2017	-	---	---	590x325	7640	590x325	7641	330x280	7639
SUZUKI	GSX-S 1000 Katana	WDG0	e4*00051 (VO)	2019	-	---	---	355x335	3637	385x335	3638	---	---
SUZUKI	GSX R 1100	GV 73 A	EBE	91-	-	270x430	0506	345x440	0561	---	---	---	---
SUZUKI	GSX R 1100	GV 73 B	EBE	91-	-	270x430	0506	345x440	0561	---	---	---	---
SUZUKI	GSX R 1100	GV 73 C	F024	91-	-	270x430	0506	345x440	0561	---	---	---	---
SUZUKI	GSX R 1100 W	GU 75 B	EBE	93-	-	320x430	0579	410x420	0609	---	---	---	---
SUZUKI	GSX R 1100 W	GU 75 C	G253	93-	-	320x430	0579	410x420	0609	---	---	---	---
SUZUKI	GSX R 1100 W	GU 75 B	EBE	95-	-	375x415	0607	450x430	0617	---	---	---	---
SUZUKI	GSX R 1100 W	GU 75 C	G253	95-	-	375x415	0607	450x430	0617	---	---	---	---
SUZUKI	GSF 1200 S Bandit	GV 75 A	H344	96-	-	315x360	0445	385x355	0460	---	---	---	---
SUZUKI	GSF 1200 S Bandit	WVA9	e4*0086	2001	-	385x355	0697	470x370	0702	---	---	375x375	1116
SUZUKI	GSF 1200 S Bandit	WVCB	e4*0850*	2006	-	375x375	2098	410x355	2125	---	---	340x360	2107
SUZUKI	GSF 1250 S Bandit	WVCH	e4*1300*	2007	-	375x375	2098	410x355	2125	---	---	340x360	2107
SUZUKI	GSF 1250 S Bandit	WVCH	e4*1300*	2015	-	---	---	420x360	7637	420x360	7638	380x360	7636
SUZUKI	GSX 1250 FA	WVCH	e4*1300*	2010	-	340x390	4632	450x395	4633	---	---	340x400	4665
SUZUKI	GSX 1300 R Hayabusa	WVA1	e4*0012*	99-	-	380x440	0951	470x425	0952	---	---	370x450	0953
SUZUKI	GSX 1300 R Hayabusa	WVA1	e4*0852*	2006	-	380x440	0951	470x425	0952	---	---	370x450	0953
SUZUKI	GSX 1300 R Hayabusa	WVCK	e4*1618*	2008	2013	400x440	4825	---	---	---	---	390x440	4826
TRIUMPH	Daytona 600	806 LW	e11*0082*	2006	-	---	---	---	---	---	---	410x370	1928
TRIUMPH	Daytona 650	865 LX	e11*0122*	2005	-	---	---	---	---	---	---	410x370	1928
TRIUMPH	Daytona 955 i	595 N	e11*0040*	2002	-	---	---	---	---	---	---	280x410	1927
TRIUMPH	Daytona 675	D67LC	e11*0253*	2006	-	---	---	---	---	---	---	415x350	4108
TRIUMPH	Daytona 675	D67LC	e11*0803*	2009	-	---	---	---	---	---	---	440x300	4939
TRIUMPH	Daytona 675	H67	e11*1592*	2013	-	---	---	---	---	---	---	390x300	6498
TRIUMPH	Tiger 1050	115 NG	e11*0440*	2007	-	---	---	470x350	4359	470x350	5919	---	---
TRIUMPH	Tiger Sport 1050	115 NG	e11*1604*	2013	-	---	---	470x350	4359	470x350	5919	---	---

Hersteller	Handelsbezeichnung	Fahrzeugtyp	ABE- Nr. / EG- BE	Baujahr		VS1		VS2		VS2.1, VS2.2, VS2.3, VS2.4		VS3	
				von	bis	STANDARD		TOURING		TOURING		RACING	
						HxB	Teile-Nr.	HxB	Teile-Nr.	HxB	Teile-Nr.	HxB	Teile-Nr.
TRIUMPH	Tiger Sport	NH01	e11*00213 (VO)	2016	-	---	---	615x440	9200	615x440	9201	---	---
TRIUMPH	Tiger 800, XC	A08	e11*1048*	2011	-	350x325	5604	490x430	5652	490x430	5918	280x300	5605
TRIUMPH	Tiger 800 XRX, XCX	A082	e11*1831*	2015	-	---	---	490x430	5652	490x430	5918	---	---
TRIUMPH	Tiger 800 XRX, XCX	C301	e11*00282 (VO)	2018	-	---	---	550x440	9656	550x440	9658	---	---
TRIUMPH	Tiger 800 XRX, XCX	C302	e11*00286 (VO)	2018	-	---	---	550x440	9656	550x440	9658	---	---
TRIUMPH	Tiger 900	C701	e9*11520 (VO)	2020	-	---	---	550x390	20375	550x390	20376	---	---
TRIUMPH	Tiger 900	C702	e9*11521 (VO)	2020	-	---	---	550x390	20375	550x390	20376	---	---
TRIUMPH	Tiger Explorer	V13VG	e11*1228*	2012	-	---	---	560x510	6000	560x510	6006	---	---
TRIUMPH	Tiger Explorer XC. , XR.	C201	e11*00215 (VO)	2015	-	---	---	490x430	5652	490x430	5918	---	---
TRIUMPH	Tiger Explorer XC. , XR.	V201	e11*00208 (VO)	2016	-	---	---	630x410	8915	630x410	8916	---	---
TRIUMPH	Tiger Explorer XC. , XR.	V301	e11*00283 (VO)	2018	-	---	---	620x495	9613	650x495	9614	---	---
TRIUMPH	Triumph 1200 Alpine, Desert	V301A	e5*00008 (VO)	2018	-	---	---	620x495	9613	650x495	9614	---	---
YAMAHA	TZR 50	---	EBE	98-	-	365x300	0085	---	---	---	---	290x400	0902
YAMAHA	TZR 50	---	EBE	2003	-	365x300	1596	---	---	---	---	260x300	1618
YAMAHA	TZR 80	---	EBE	98	-	365x300	0085	---	---	---	---	290x400	0902
YAMAHA	YZF-R 125	RE 06	e13*0248*	2008	-	---	---	---	---	---	---	370x255	4637
YAMAHA	YZF-R 125	RE 11	e13*0697*	2014	-	---	---	---	---	---	---	370x255	4637
YAMAHA	YZF-R 125	RE 29	e13*00076 (VO)	2017	-	---	---	---	---	---	---	370x255	4637
YAMAHA	YZF-R 125	RE 39	e13*00519 (VO)	2019	-	---	---	---	---	---	---	330X310	3619
YAMAHA	YZF-R 125	RE 40	e13*00900 (VO)	2021	-	---	---	---	---	---	---	330X310	3619
YAMAHA	RD 350 LC	1 WW	E144	86	-	340x305	0774	---	---	---	---	---	---
YAMAHA	RD 350 LC	1 WX	E140	86	-	340x305	0774	---	---	---	---	---	---
YAMAHA	FZR 600	3 HE	F103	91	-	440x395	0591	440x410	0593	---	---	---	---
YAMAHA	FZR 600	3 RG	F152	91	-	440x395	0591	440x410	0593	---	---	---	---
YAMAHA	FZR 600	3 RH	F153	91	-	440x395	0591	440x410	0593	---	---	---	---
YAMAHA	FZR 600 R	4 JH	G653	94	-	310x465	0494	365x450	0501	---	---	---	---
YAMAHA	FZR 600 R	4 MH	G663	94	-	310x465	0494	365x450	0501	---	---	---	---
YAMAHA	YZF 600 R	4 WD	H653	96	-	600x465	0594	460x340	0602	---	---	330x390	1124
YAMAHA	YZF 600 R	4 TV	H441	96	-	600x465	0594	460x340	0602	---	---	330x390	1124
YAMAHA	YZF- R6	RJ 03	K265	99	-	370x255	0625	360x350	0626	---	---	310x360	0021
YAMAHA	YZF- R6	RJ 05	e13*0060*	2003	-	445x375	1327	445x370	1329	---	---	450x380	1328
YAMAHA	YZF- R6, S	RJ 09	e13*0079*	2005	-	445x375	1327	445x370	1329	---	---	450x380	1328

S22_38182*26

Hersteller	Handelsbezeichnung	Fahrzeugtyp	ABE- Nr. / EG- BE	Baujahr		VS1		VS2		VS2.1, VS2.2, VS2.3, VS2.4		VS3	
				von	bis	STANDARD		TOURING		TOURING		RACING	
						HxB	Teile-Nr.	HxB	Teile-Nr.	HxB	Teile-Nr.	HxB	Teile-Nr.
YAMAHA	YZF- R6	RJ 11	e13*0038*	2006	-	345x345	4058	---	---	---	---	320x370	4059
YAMAHA	YZF- R6	RJ 15	e13*0223*	2008	-	320x370	4634	---	---	---	---	350x370	4635
YAMAHA	YZF- R6	RJ 27	e13*00081 (VO)	2017	2019	---	---	---	---	---	---	360x285	9723
												370x280	3633
YAMAHA	FZS 600 Fazer	RJ 02	H988	98	-	325x315	0901	395x315	0946	---	---	325x360	1014
YAMAHA	FZS 600 Fazer	RJ 02	H988	2000	-	325x315	0901	395x315	0946	---	---	325x360	1014
YAMAHA	FZS 600 Fazer	RJ 02	H988	2002	-	480x420	1110	455x330	1111	---	---	410x320	1112
YAMAHA	FZ 6 Fazer	RJ 07	e13*0072*	2004	-	480x550	1645	590x540	1647	---	---	550x570	1646
YAMAHA	FZ 6 Fazer S2	RJ 14	e13*0111*	2007	-	---	---	475x335	4367	475x335	5908	420x330	4366
YAMAHA	FZ 8 Fazer	RN25	e13*0393*	2010	-	---	---	534x525	5610	---	---	430x330	5572
YAMAHA	XJ 600 S Diversion	4 BR	F904		92	---	---	370x300	4340	---	---	---	---
YAMAHA	XJ 600 S Diversion	4 BR	F904	93	-	---	---	380x340	0759	---	---	---	---
YAMAHA	XJ 600 S Diversion	4 BRA	F945	93	-	---	---	380x340	0759	---	---	---	---
YAMAHA	XJ 600 S Diversion	4 BRB	F944	93	-	---	---	380x340	0759	---	---	---	---
YAMAHA	XJ 6 Diversion	RJ 19	e13*0323*	2009	-	455x415	4936	505x415	4938	505x415	5909	400x340	4937
YAMAHA	XJ 600 S Diversion	4 BR	F904	96	-	---	---	410x310	0584	---	---	---	---
YAMAHA	XJ 600 S Diversion	4 BRA	F945	96	-	---	---	410x310	0584	---	---	---	---
YAMAHA	XJ 600 S Diversion	4 BRB	F944	96	-	---	---	410x310	0584	---	---	---	---
YAMAHA	XJ 600 S Diversion	4LX	G595	96	-	---	---	410x310	0584	---	---	---	---
YAMAHA	XJ 600 S Diversion	RJ 01	H810	97	-	---	---	410x310	0584	---	---	---	---
YAMAHA	XJ 600	51J	D399	84	-	245x345	0502	395x350	0618	---	---	---	---
YAMAHA	XJ 600	3 KM	F635	90	-	245x345	0502	395x350	0618	---	---	---	---
YAMAHA	XJ 600	3 KN	F634	90	-	245x345	0502	395x350	0618	---	---	---	---
YAMAHA	XJ 6	RJ 19	e13*0323*	2010	-	---	---	500x360	5548	500x360	5910	390x260	5547
YAMAHA	XTZ 660 Tenere	4 BW	EBE		-	235x265	0339	315x275	0341	---	---	---	---
YAMAHA	XTZ 660 Tenere	3 YF	F680	91-	-	235x265	0339	315x275	0341	---	---	---	---
YAMAHA	XT 660 R	DM 01	e13*0085*	2004	-	---	---	315x305	1648	---	---	---	---
YAMAHA	XT 660 X	DM 01	e13*0085*	2004	-	---	---	315x305	1648	---	---	---	---
YAMAHA	XT 660 X	DM 01	e13*0085*	2007	-	---	---	470x380	4358	---	---	---	---
YAMAHA	XT 660 Z Tenere	DM 02	e13*0272*	2008	-	---	---	385x470	4636	385x470	5912	---	---
YAMAHA	XTZ690 (Tenere 700)	DM 07	e13*00648 (VO)	2019	-	---	---	415x310	3727	420x310	3728	---	---
YAMAHA	XTZ690-U (Tenere 700,35kW)	DM 08	e13*00649 (VO)	2019	-	---	---	415x310	3727	420x310	3728	---	---
YAMAHA	XTZ690 (Tenere Rally)	DM 11	e13*00986 (VO)	2021	-	---	---	415x310	3727	420x310	3728	240x250	20834

Hersteller	Handelsbezeichnung	Fahrzeugtyp	ABE- Nr. / EG- BE	Baujahr		VS1		VS2		VS2.1, VS2.2, VS2.3, VS2.4		VS3	
				von	bis	STANDARD		TOURING		TOURING		RACING	
						HxB	Teile-Nr.	HxB	Teile-Nr.	HxB	Teile-Nr.	HxB	Teile-Nr.
YAMAHA	FZ 750	1 FN	D795	87	-	---	---	410x310	0595	---	---	---	---
YAMAHA	FZ 750	2 KK	E486	87	-	---	---	410x310	0595	---	---	---	---
YAMAHA	FZ 750	2 MG	EBE	87	-	---	---	410x310	0595	---	---	---	---
YAMAHA	FZ 750	3 KT	F558	87	-	---	---	410x310	0595	---	---	---	---
YAMAHA	XTZ 750 Sup. Tenere	3 LD	EBE		-	295x295	0807	350x295	0808	---	---	---	---
YAMAHA	XTZ 750 Sup. Tenere	3 WM	F343	90	-	295x295	0807	350x295	0808	---	---	---	---
YAMAHA	XJ 750	41 Y	D319		-	245x345	0502	395x350	0618	---	---	---	---
YAMAHA	YZF 750 R	4 HN	G346	93	-	320x435	0601	420x445	0596	---	---	---	---
YAMAHA	MXT 850 (Niken)	RN 58	e13*00332 (VO)	2018	-	---	---	608x490	2385	630x490	3535	---	---
YAMAHA	MT-07 Tracer	RM 14	e13*00024 (VO)	2016	-	---	---	600x360	9212	600x360	9213	406x290	9211
YAMAHA	MTT690-A (Tracer 700)	RM 14	e13*00024 (VO)	2019	-	---	---	600x360	9212	600x360	9213	406x290	9211
YAMAHA	MT-07 Tracer	RM 15	e13*00025 (VO)	2016	-	---	---	600x360	9212	600x360	9213	406x290	9211
YAMAHA	MTT690-U (Tracer 35kW)	RM 15	e13*00025 (VO)	2019	-	---	---	600x360	9212	600x360	9213	406x290	9211
YAMAHA	MTT690-A (MT-07 Tracer)	RM 30	e13*00782 (VO)	2020	-	---	---	583x375	20434	583x375	20435	382x250	20433
YAMAHA	MTT690-A (MT-07 Tracer,35kW)	RM 31	e13*00783 (VO)	2020				583x375	20434	583x375	20435	382x250	20433
YAMAHA	TDM 850	4TX	H442	96-	-	---	---	410x310	0584	---	---	---	---
YAMAHA	MT-09 Tracer	RN 29	e13*0643*	2015	-	---	---	630x405	7646	---	---	390x290	7645
YAMAHA	MT-09 Tracer	RN 43	e13*00002 (VO)	2017	-	---	---	630x405	7646	---	---	390x290	7645
YAMAHA	MTT 850 (Tracer, GT)	RN 57	e13*00286 (VO)	2018	-	---	---	645x445	9725	645x660	9726	376x287	9724
YAMAHA	MTT 850 (Tracer, GT)	RN 70	e13*00954 (VO)	2021	-	---	---	645x445	3762	660x445	3755	---	---
YAMAHA	MTN 1000 (MT-10)	RN 45	e13*00008 (VO)	2016	-	---	---	500x350	8918	500x350	8919	360x320	8917
YAMAHA	MTN 1000 D (MT-10 SP)	RN 45	e13*00008 (VO)	2017	-	---	---	500x350	8918	500x350	8919	360x320	8917
YAMAHA	TDM 900	RN 08	e13*0053*	2002	-	500x350	1106	400x310	1107	---	---	---	---
YAMAHA	TDM 900	RN 11	e13*0074*	2004	-	500x350	1106	400x310	1107	---	---	---	---
YAMAHA	TDM 900	RN 18	e13*0099*	2006	-	500x350	1106	400x310	1107	---	---	---	---
YAMAHA	XJ 900 S Diversion	4 KM	G844	95	-	---	---	465x370	0582	---	---	---	---
YAMAHA	XJ 900	31 A	C971		-	245x345	0502	395x350	0618	---	---	---	---
YAMAHA	XJ 900	58 L	D771	85	-	245x345	0502	395x350	0618	---	---	---	---
YAMAHA	XJ 900	4 BB	F609	90	-	245x345	0502	395x350	0618	---	---	---	---
YAMAHA	FZR 1000	2 LA, 2 LE	E558, ---		88	365x450	0522	415x450	0583	---	---	---	---
YAMAHA	FZR 1000	2 RG, 2RH	EBE		88	365x450	0522	415x450	0583	---	---	---	---
YAMAHA	FZR 1000 Exup	3LE,3LF,3GM	F128 ,--,--	89-	-	305x440	0528	335x460	0559	---	---	---	---
YAMAHA	FZR 1000 Exup	3LE,3LF,3GM	F128 ,--,--	91-	-	440x400	0569	470x400	0574	---	---	---	---

S22 38182*26

Hersteller	Handelsbezeichnung	Fahrzeugtyp	ABE- Nr. / EG- BE	Baujahr		VS1		VS2		VS2.1, VS2.2, VS2.3, VS2.4		VS3	
				von	bis	STANDARD		TOURING		TOURING		RACING	
						HxB	Teile-Nr.	HxB	Teile-Nr.	HxB	Teile-Nr.	HxB	Teile-Nr.
YAMAHA	FZR 1000 Exup	3LE,3LF,3GM	F128 ,--,--	94	-	325x450	0532	400x450	0573	---	---	---	---
YAMAHA	YZF 1000 R	4VD	H443	96	-	400x400	0534	455x400	0545	---	---	420x445	0287
YAMAHA	YZF 1000 R1	RN 01	H917	98	-	375x310	0842	410x310	0811	---	---	365x305	0025
YAMAHA	YZF 1000 R1	RN 04	e1*00063*	2000	-	440x310	0019	480x310	0027	---	---	410x315	0044
YAMAHA	YZF 1000 R1	RN 09	e13*0054*	2002	-	455x310	1143	515x310	1144	---	---	455x300	1145
YAMAHA	YZF 1000 R1	RN 12	e13*0084*	2004	-	415x300	1649	510x305	1881	---	---	480x330	1650
YAMAHA	YZF 1000 R1	RN 15	EBE	2004	-	415x300	1649	510x305	1881	---	---	480x330	1650
YAMAHA	YZF 1000 R1	RN 19	e13*0163*	2007	-	450x380	4364	---	---	---	---	420x350	4365
YAMAHA	YZF 1000 R1	RN 22	e13*0325*	2009	-	440x380	4934	---	---	---	---	450x360	4935
YAMAHA	YZF 1000 R1	RN 32	e13*0740*	2015	-	---	---	---	---	---	---	355x290	7648
YAMAHA												365x305	3632
YAMAHA	YZF 1000 R1	RN 49	e13*00104 (VO)	2017	-	---	---	---	---	---	---	355x290	7648
YAMAHA												365x305	3632
YAMAHA	YZF 1000 R1 M	RN 49	e13*00104 (VO)	2018	2019	---	---	---	---	---	---	360x320	7648
YAMAHA												365x305	3632
YAMAHA	YZF 1000 R1, D	RN 65	e13*00604 (VO)	2020		---	---	---	---	---	---	335x295	3826
YAMAHA												335x298	3827
YAMAHA	YZF 690 (YZF R7)	RM39	e13*01110 (VO)	2022	-	---	---	---	---	---	---	360x285	9723
YAMAHA				2022	-	---	---	---	---	---	---	370x280	9723
YAMAHA	YZF 690-U (YZF R7)	RM40	e13*01111 (VO)	2022	-	---	---	---	---	---	---	360x285	9723
YAMAHA				2022	-	---	---	---	---	---	---	370x280	9723
YAMAHA	YZF R3	RH 07	e13*0741*	2015	-	---	---	---	---	---	---	300x295	7649
YAMAHA	YZF R3	RH 12	e13*00164 (VO)	2019	-	---	---	---	---	---	---	330x280	3737
YAMAHA	FZS 1000 Fazer	RN 06	e1*00103*	2001	-	325x270	0164	380x330	0168	---	---	340x320	1053
YAMAHA	FZS 1000 Fazer	RN 14	e1*0021*	2004	-	325x270	0164	380x330	0168	---	---	340x320	1053
YAMAHA	FZ-1 Fazer	RN 16	e1*0040*	2006	-	430x330	4060	480x420	4101	480x420	5907	410x300	4061
YAMAHA	BT 1100 bulldog	RP 05	e1*00116*	2002	-	---	---	---	---	---	---	330x270	1307
YAMAHA	FJ 1200	3 YA	F559	91-	-	470x375	0571	520x375	0597	---	---	---	---
YAMAHA	XT 1200 Super Tenere	DP 01	e13*0388*	2010	-	---	---	505x450	5568	505x450	5911	---	---
YAMAHA	XT 1200 Super Tenere	DP 04	e13*0653*	2014	-	---	---	600x465	7541	630x465	7600	---	---
YAMAHA	XT 1200 Super Tenere	DP 07	e13*00062 (VO)	2017	-	---	---	600x465	7541	630x465	7600	---	---
YAMAHA	FJR 1300	RP 04	e13*0045*	2001	-	---	---	540x520	1281	---	---	---	---
YAMAHA	FJR 1300	RP 08	e13*0062*	2003	-	---	---	540x520	1281	---	---	---	---
YAMAHA	FJR 1300	RP 11	e13*0081*	2003	-	---	---	540x520	1281	---	---	---	---

S22_38182*26

Hersteller	Handelsbezeichnung	Fahrzeugtyp	ABE- Nr. / EG- BE	Baujahr		VS1		VS2		VS2.1, VS2.2, VS2.3, VS2.4		VS3	
				von	bis	STANDARD		TOURING		TOURING		RACING	
						HxB	Teile-Nr.	HxB	Teile-Nr.	HxB	Teile-Nr.	HxB	Teile-Nr.
YAMAHA	FJR 1300	RP 13	e13*0041*	2006	-	---	---	500x505	4103	---	---	---	---
YAMAHA	FJR 1300 A, AS	RP 23	e13*0574*	2013	-	---	---	560x570	6483	560x570	6501		
YAMAHA	FJR 1300 A, AS	RP 28	e13*00001 (VO)	2016	-	---	---	560x570	6483	560x570	6501		

Anmerkung 1):

Die in der Original- Scheibe vorhandene Begrenzungsleuchte (Standlicht) muss in die Austausch- Scheibe übernommen werden.

Anmerkung (VO) zu der Spalte "ABE / EG-BE"

Diese Fahrzeuge wurden nach der neuen Rechtsvorschrift VO(EU), Nr. 168/2013, Anh. VIII genehmigt, alle anderen Krafräder haben entweder eine nationale Genehmigung "ABE" nach §20 StVZO oder eine europäische Typgenehmigung nach den Vorschriften 92/61/EG bzw. 2002/24/EG

TOURING SCREEN WITH VISOR AT LOWER POSITION

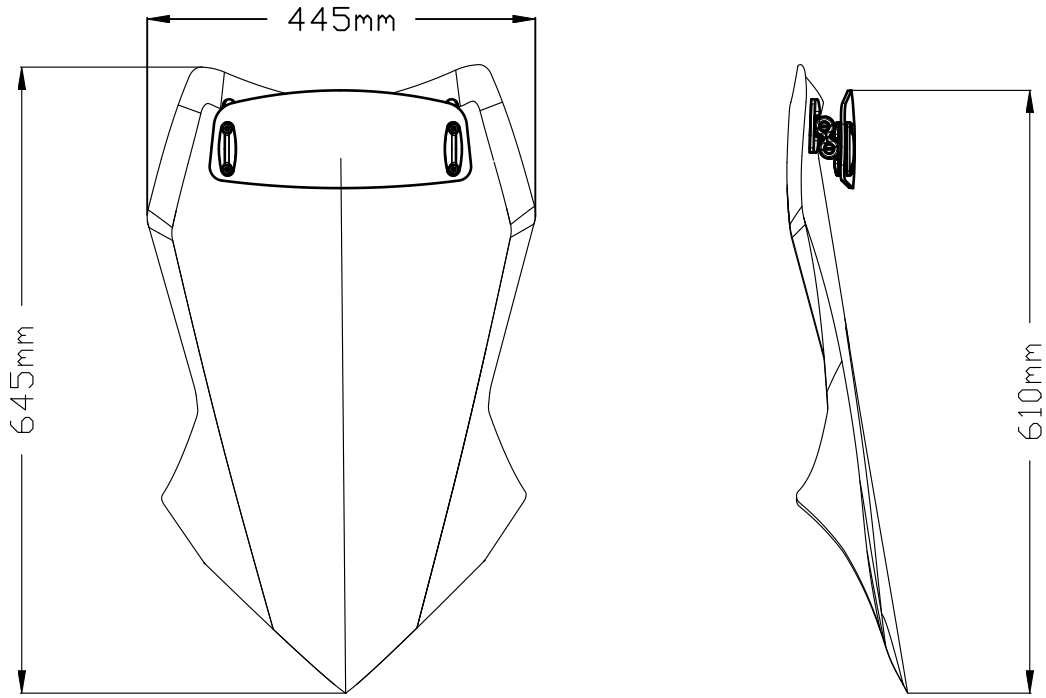

TOURING SCREEN WITH VISOR AT UPPER POSITION

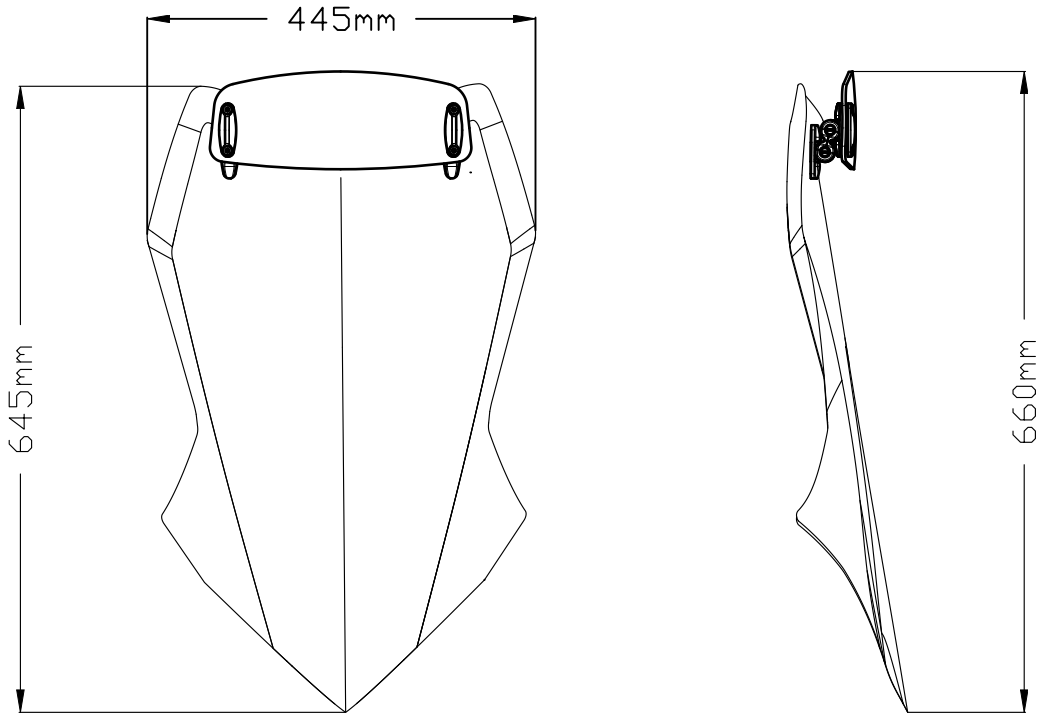

S22 38182*26

	<p>PROJECT NAME: TOURING SCREEN WITH VISOR FOR YAMAHA MT09 TRACER '18-</p>	<p>REF: 3755</p>		
	<p>Version:</p>	<p>DIN-A4</p>	<p>Hoja : 1/1</p>	
<p>DRAWN BY: VANESA LUNA</p>	<p>Description:</p> <p style="text-align: center;">VS2.3</p>	<p>MATERIAL: CN</p>	<p>THICKNESS: 4mm</p>	
<p>DATE: 30/06/2021</p>		<p>VISOR: N° 3</p>	<p>DEFLECTOR: -</p>	
<p>SCALE: 1:8</p>		<p>DIFFERENCE TO ORIGINAL:</p>		
		<p>VISOR FOR OEM SCREEN : N°3</p>		

S22 38182*26

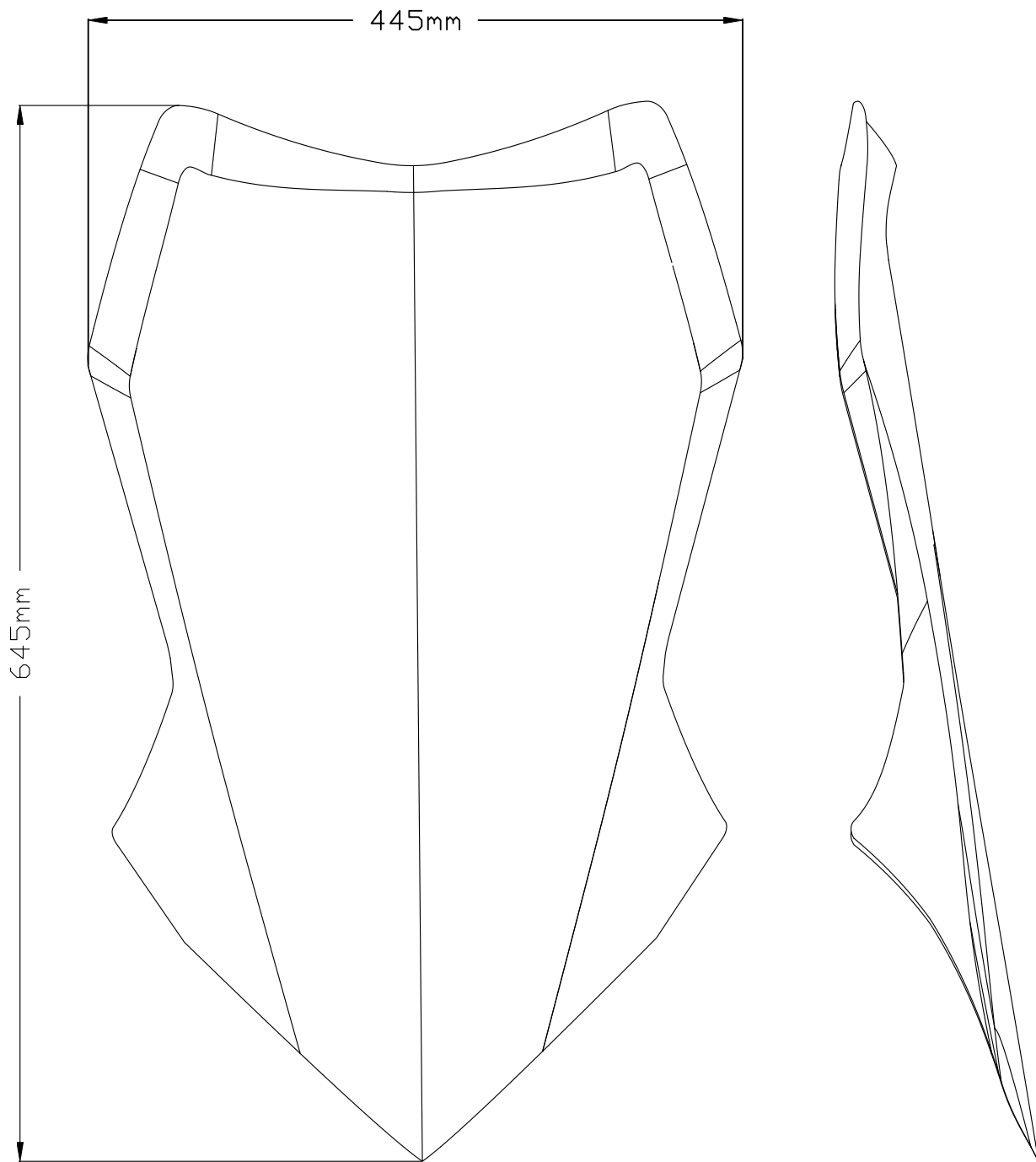

	PROJECT NAME: TOURING SCREEN YAMAHA MT09 TRACER '18-	REF: 3762	
	Version:	DIN-A4	Hoja : 1/1
DRAWN BY: VANESA LUNA	Description: <p style="text-align: center;">VS2</p>	MATERIAL: CN	THICKNESS: 4mm
DATE: 30/06/2021		VISOR: N° 3	DEFLECTOR: -
SCALE: 1:4		DIFFERENCE TO ORIGINAL:	
		VISOR FOR OEM SCREEN : N°3	

S22 38182*26

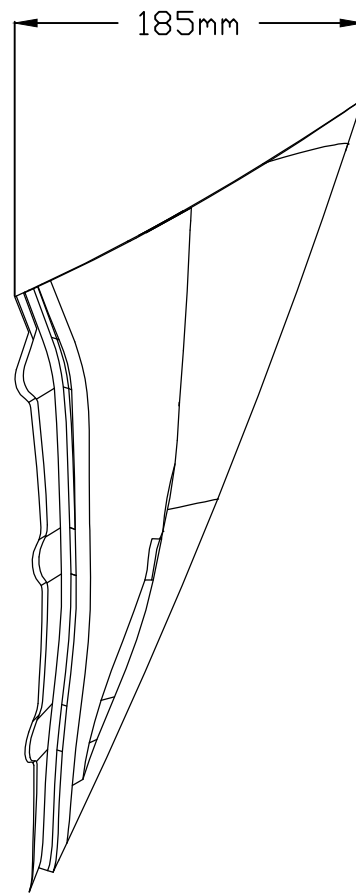
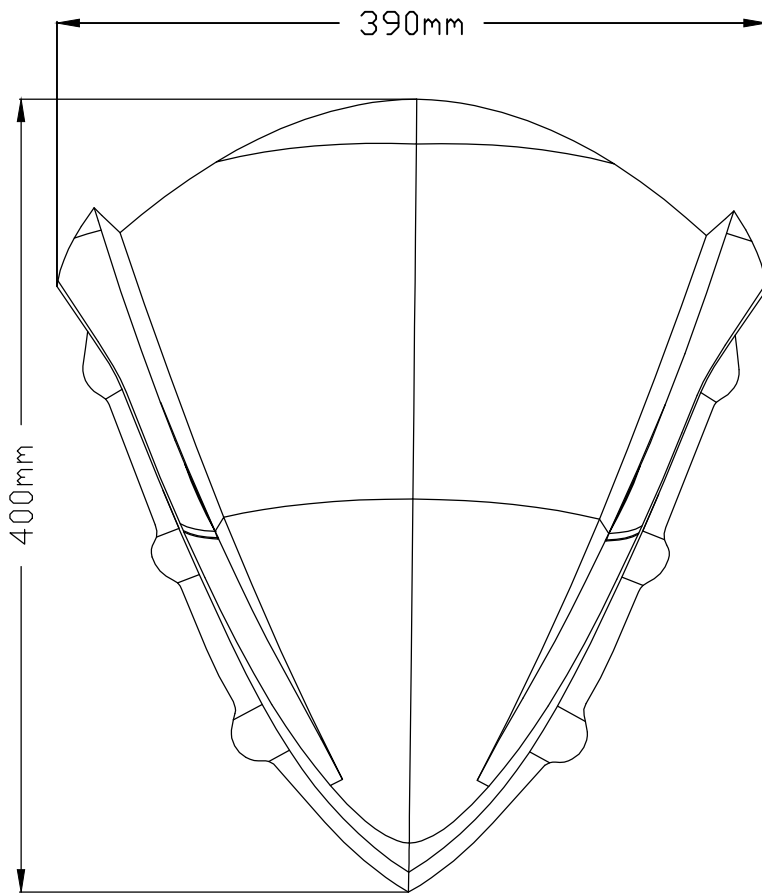

	PROJECT NAME: RACING SCREEN FOR KAWASAKI NINJA H2 SX '18	REF: 9704	
	Version:	DIN-A4	Hoja : 1/1
DRAWN BY: VANESA LUNA	Description: <div style="text-align: center; font-weight: bold; font-size: 1.2em;">VS3</div>	MATERIAL: CI30	THICKNESS: 3mm
DATE: 15/06/2018		DEFLECTOR: 4835/4717	
SCALE: 1/4		DIFFERENCE TO ORIGINAL: +15mm	
		DEFLECTOR FOR OEM SCREEN : 4835/4717	

S22 38182*26

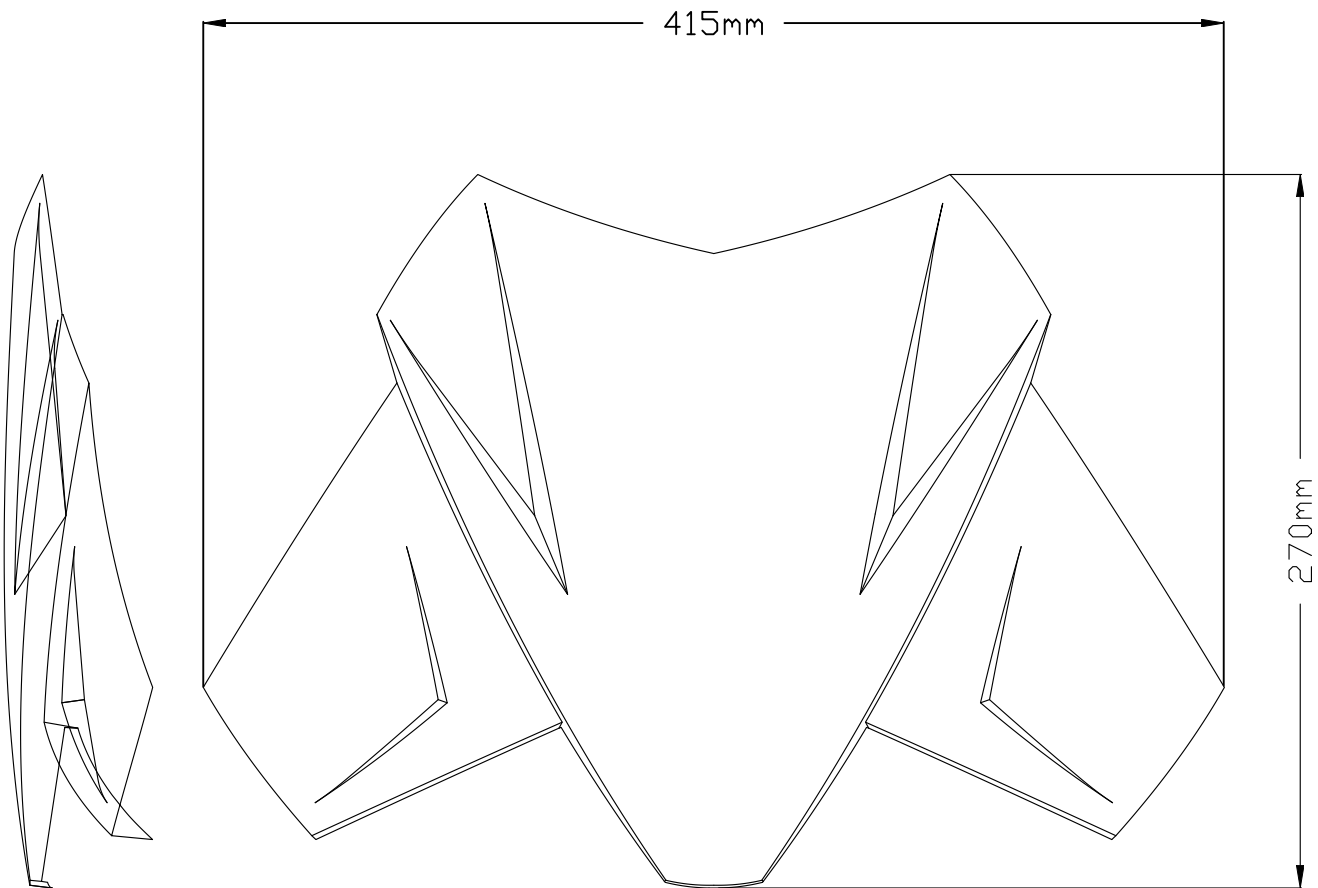

	PROJECT NAME: SPORT SCREEN FOR KTM 1290 SUPERADVENTURE R/S '21-	REF: 20401	
	Version:	DIN-A4	Hoja : 1/1
DRAWN BY: VANESA LUNA	Description: VS3	MATERIAL: CN 4	THICKNESS: 4mm
DATE: 06/09/2021		VISOR : /	
SCALE: 1:3		DIFFERENCE TO OEM SCREEN: -55mm	

S22 38182*26

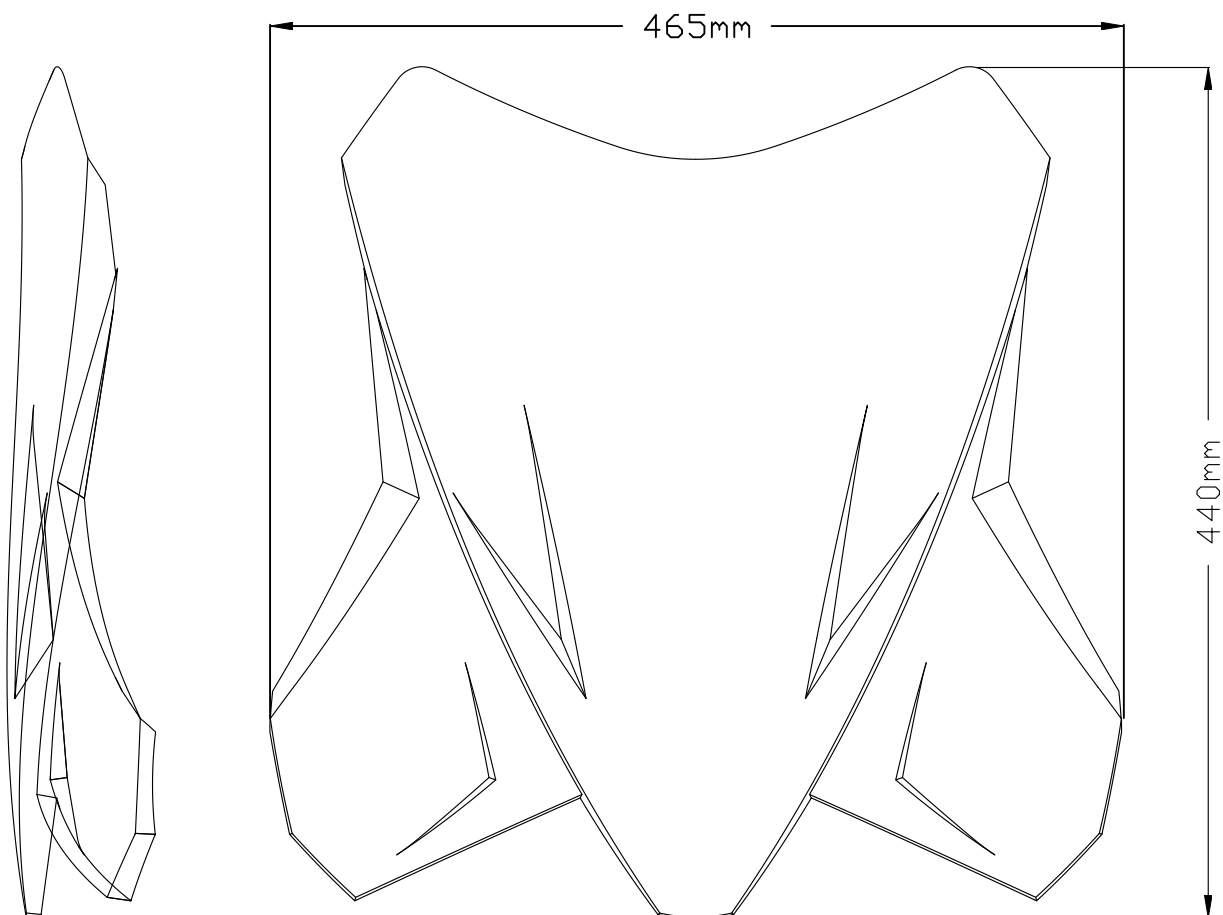

	PROJECT NAME: TOURING SCREEN FOR KTM 1290 SUPERADVENTURE R/S '21-	REF: 20422	
	Version:	DIN-A4	Hoja : 1/1
DRAWN BY: VANESA LUNA	Description: VS2	MATERIAL: CN 4	THICKNESS: 4mm
DATE: 06/09/2021		VISOR :MULTI-ADJUSTABLE VISOR 2.0	
SCALE: 1:4		DIFFERENCE TO OEM SCREEN: + 55mm	

TOURING SCREEN WITH VISOR AT LOWER POSITION

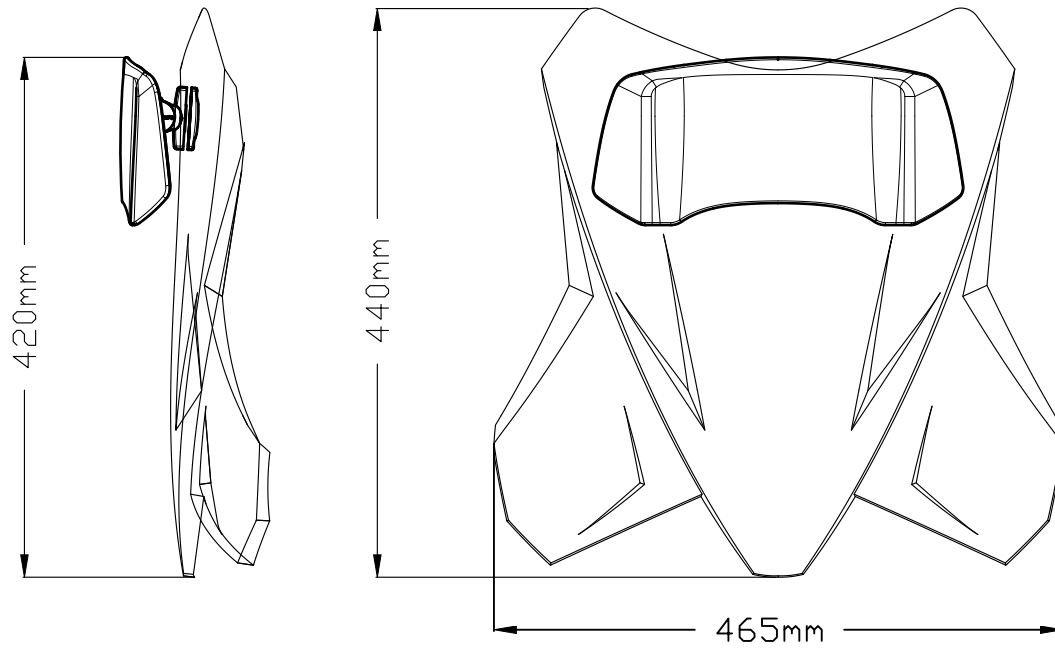

TOURING SCREEN WITH VISOR AT UPPER POSITION

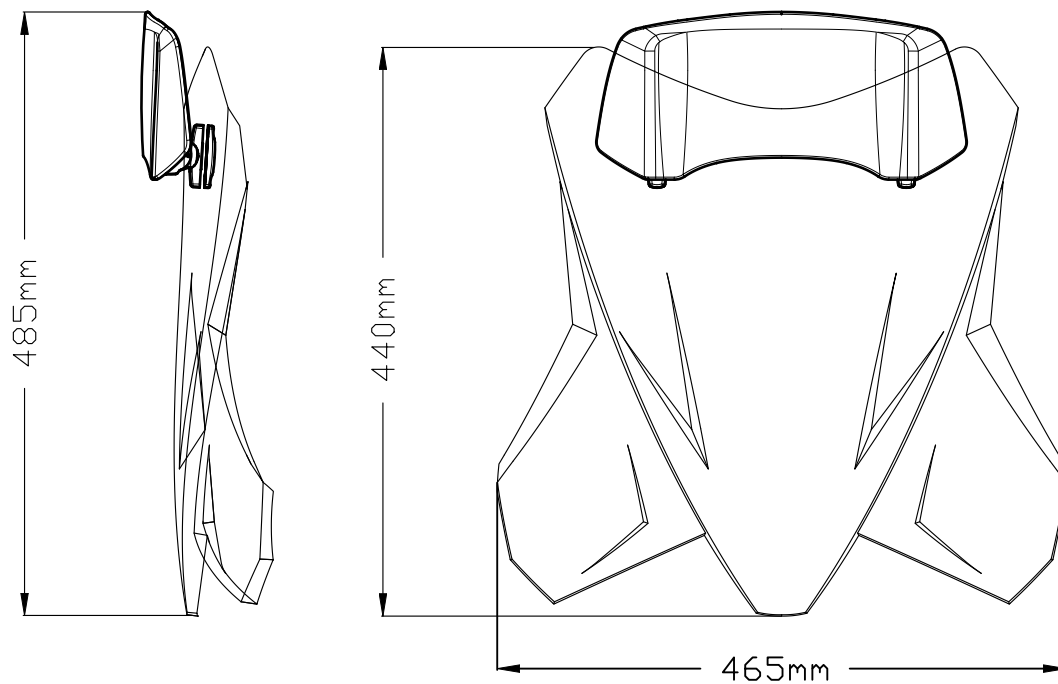

S22 38182*26

	<p>PROJECT NAME: TOURING SCREEN WITH VISOR FOR KTM 1290 SUPERADVENTURE R/S '21-</p>	<p>REF: 20586</p>	
	<p>Version:</p>	<p>DIN-A4</p>	<p>Hoja : 1/1</p>
<p>DRAWN BY: VANESA LUNA</p>	<p>Description:</p> <p style="text-align: center;">VS2.4</p>	<p>MATERIAL: CN 4</p>	<p>THICKNESS: 4mm</p>
<p>DATE: 06/09/2021</p>		<p>VISOR :MULTI-ADJUSTABLE VISOR 2.0</p>	
<p>SCALE: 1:6</p>		<p>DIFFERENCE TO OEM SCREEN: +55mm</p>	

S22 38182*26

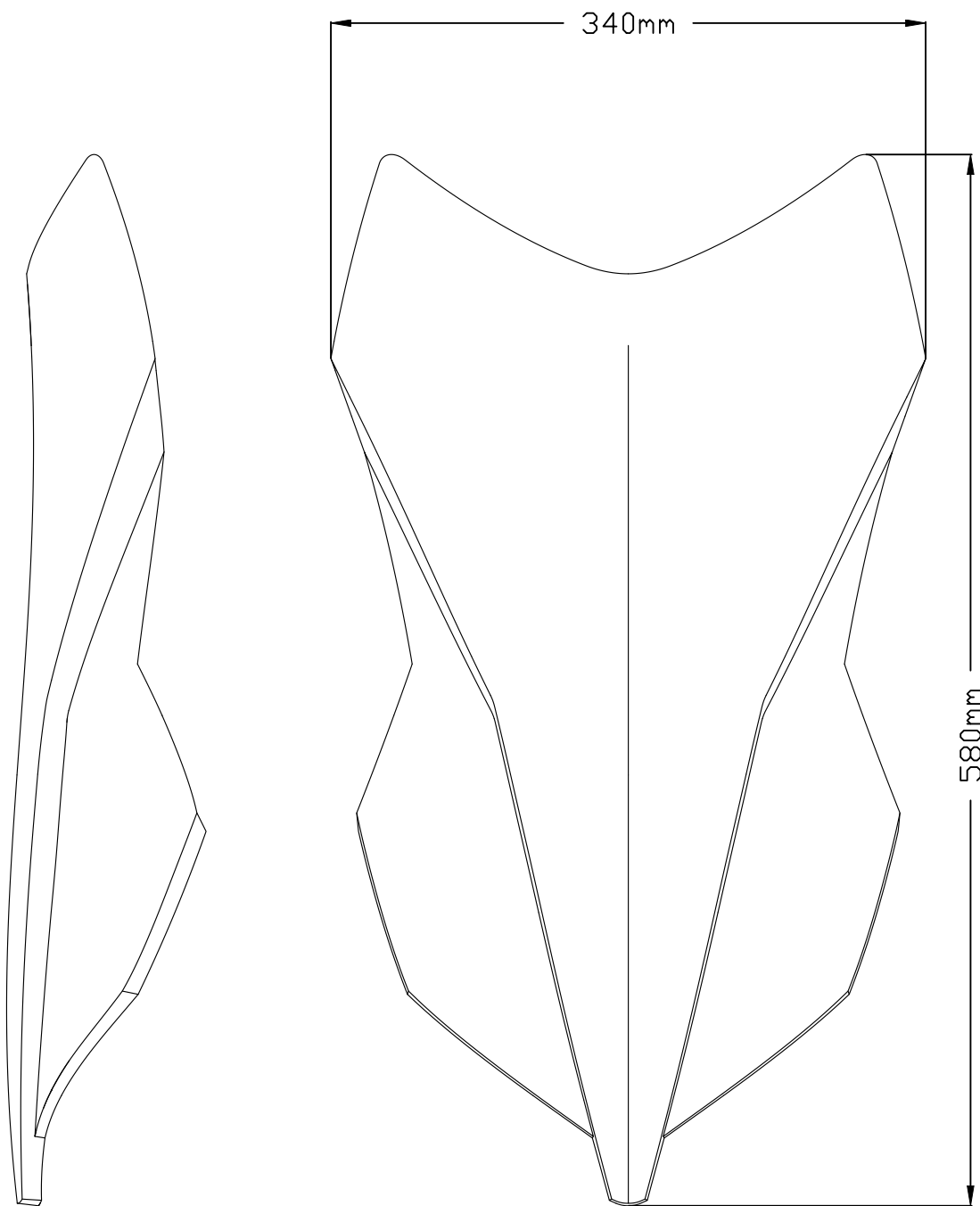

	PROJECT NAME: TOURING SCREEN FOR BENELLI TRK 251 '20-	REF: 20629	
	Version:	DIN-A4	Hoja : 1/1
DRAWN BY: VANESA LUNA	Description: VS2	MATERIAL: CN	
DATE: 30/04/2021		THICKNESS: 4mm	
SCALE: 1/4		VISOR N°: 2	
		DIFFERENCE TO ORIGINAL: +100mm	

TOURING SCREEN WITH VISOR AT LOWER POSITION

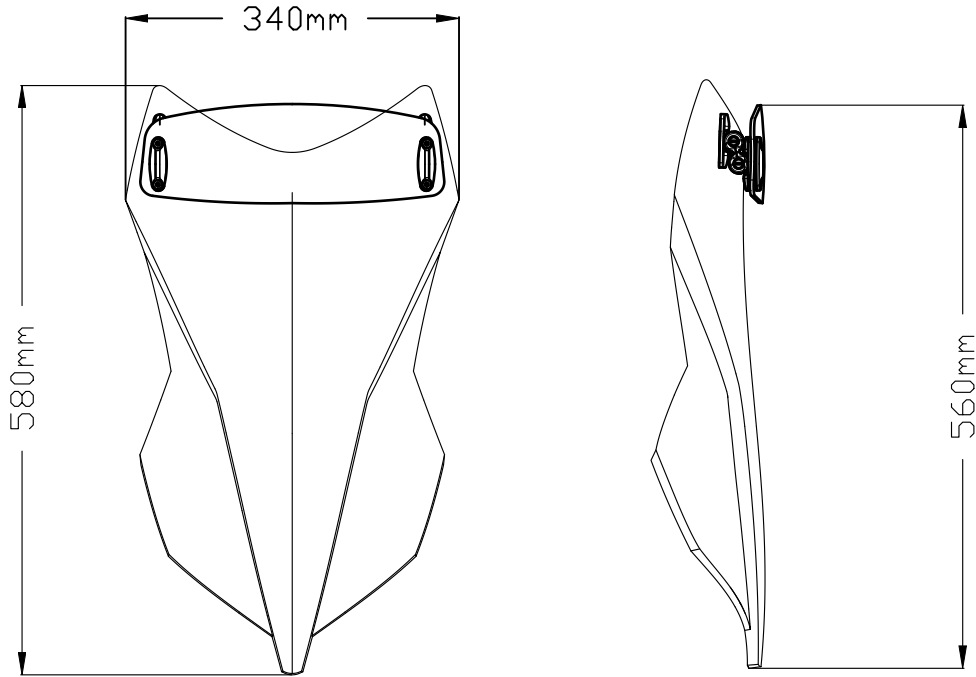

TOURING SCREEN WITH VISOR AT UPPER POSITION

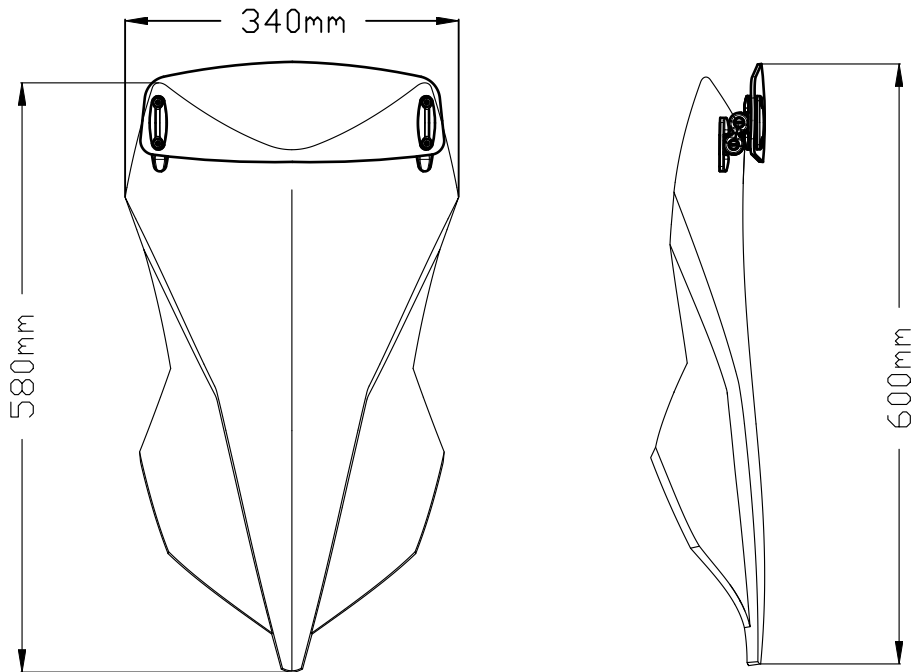

S22 38182*26

	PROJECT NAME: TOURING SCREEN WITH VISOR FOR BENELLI TRK 251 '20-	REF: 20630	
	Version:	DIN-A4	Hoja : 1/1
DRAWN BY: VANESA LUNA	Description: <p style="text-align: center;">VS2.2</p>	MATERIAL: CN	
DATE: 30/04/2021		THICKNESS: 4mm	
SCALE: 1/8		VISOR Nº: 2	
		VISOR FOR OEM SCREEN: /	

S22 38182*26

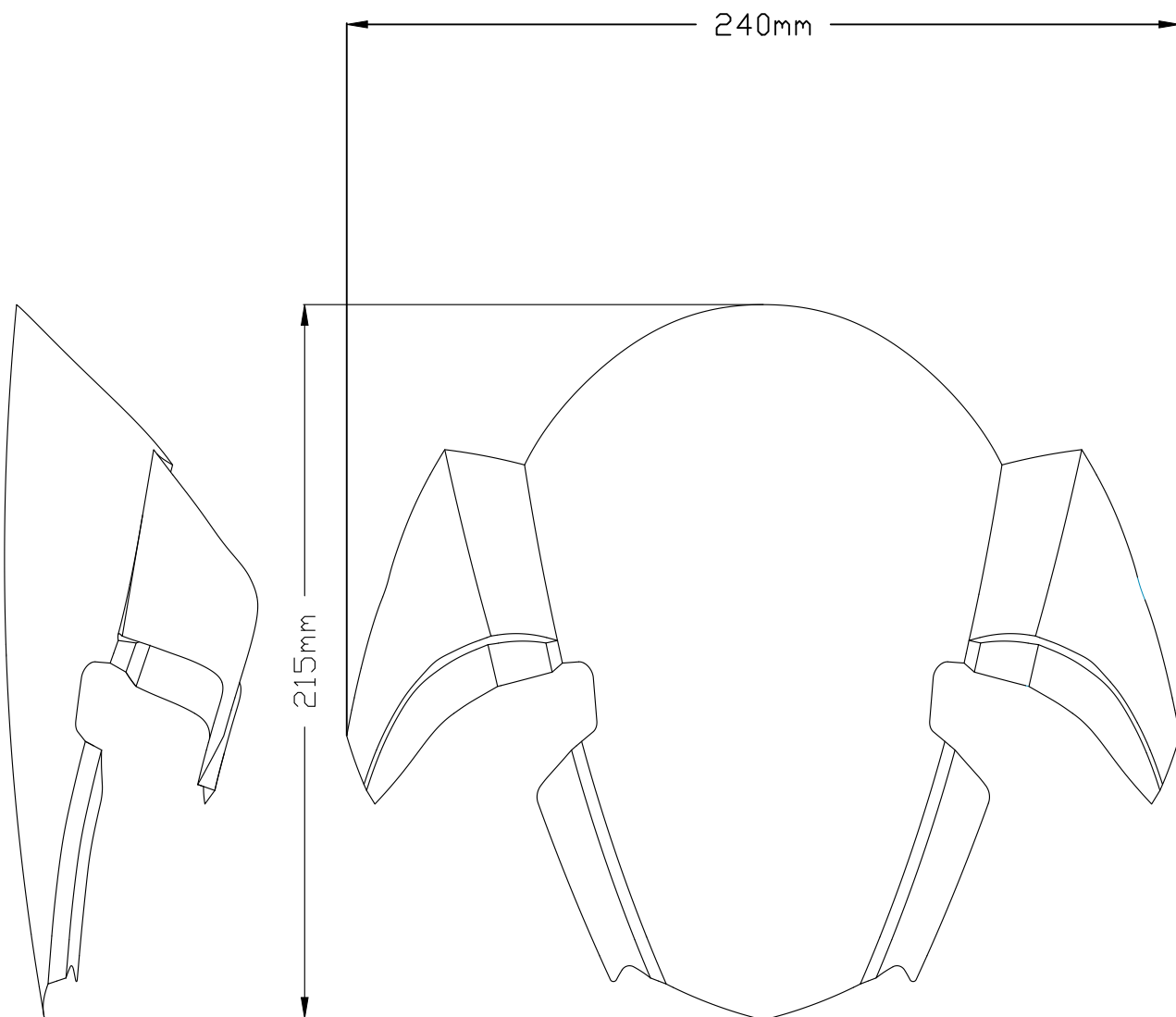

	PROJECT NAME: SPORT SCREEN FOR DUCATI MONSTER 937 '21-	REF: 20688	
	Version:	DIN-A4	Hoja : 1/1
DRAWN BY: VANESA LUNA	Description: VS3	MATERIAL: CI 30	
DATE: 23/07/2021		THICKNESS: 3 mm	
SCALE: 1:2		DIFFERENCE TO ORIGINAL SCREEN +105 mm	

S22 38182*26

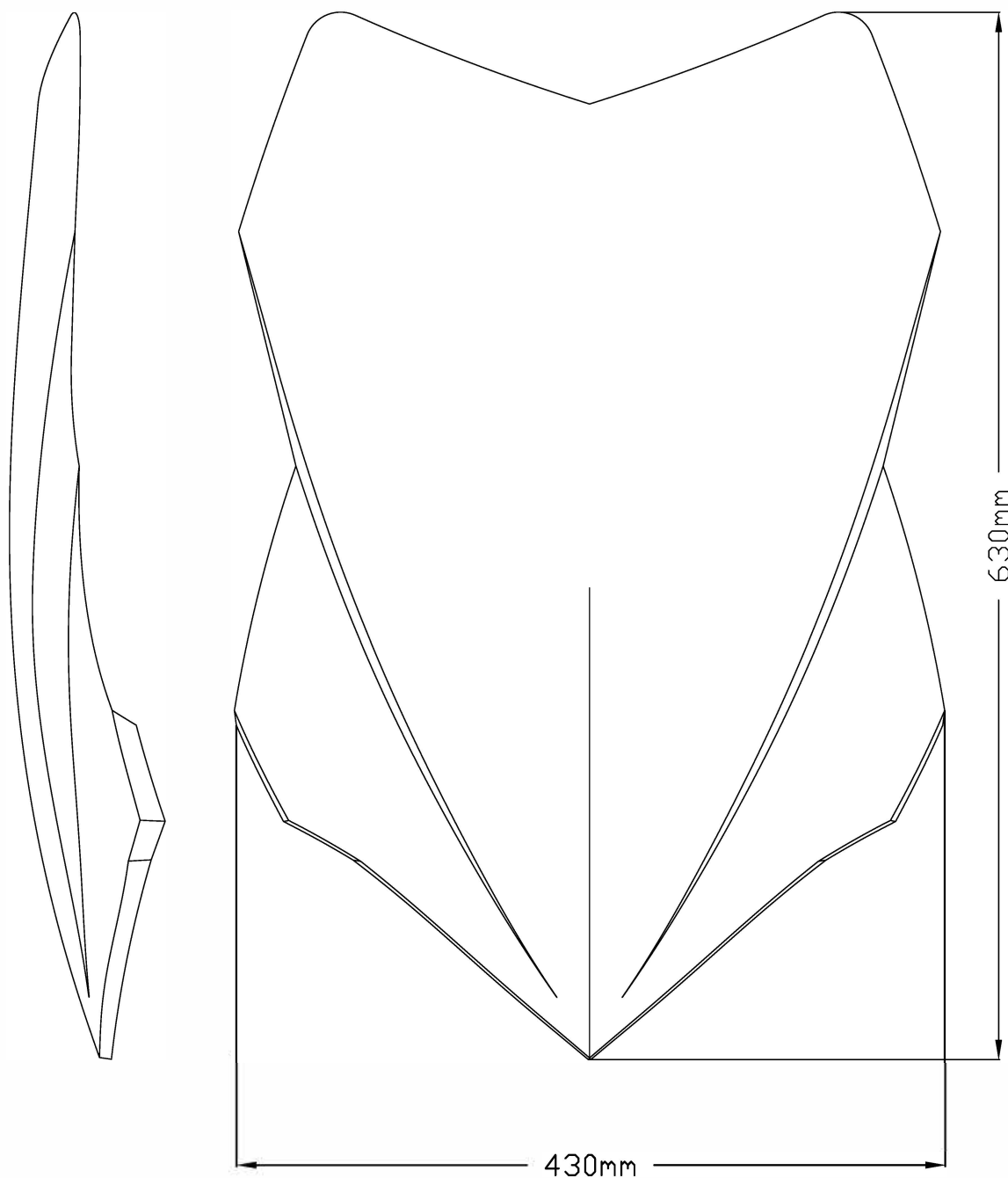

	PROJECT NAME: TOURING SCREEN FOR DUCATI MULTISTRADA V4 '21-	REF: 20728		
	Version:	DIN-A4	Hoja : 1/1	
DRAWN BY: VANESA LUNA	Description: VS2	MATERIAL: CN 4	THICKNESS: 4 mm	
DATE: 14/05/2021		VISOR: nº 3	DEFLECTOR: /	
SCALE: 1:4		DIFFERENCE TO ORIGINAL: +100mm	DEFLECTOR FOR OEM SCREEN : /	
		DEFLECTOR FOR OEM SCREEN : /		

S22 38182*26

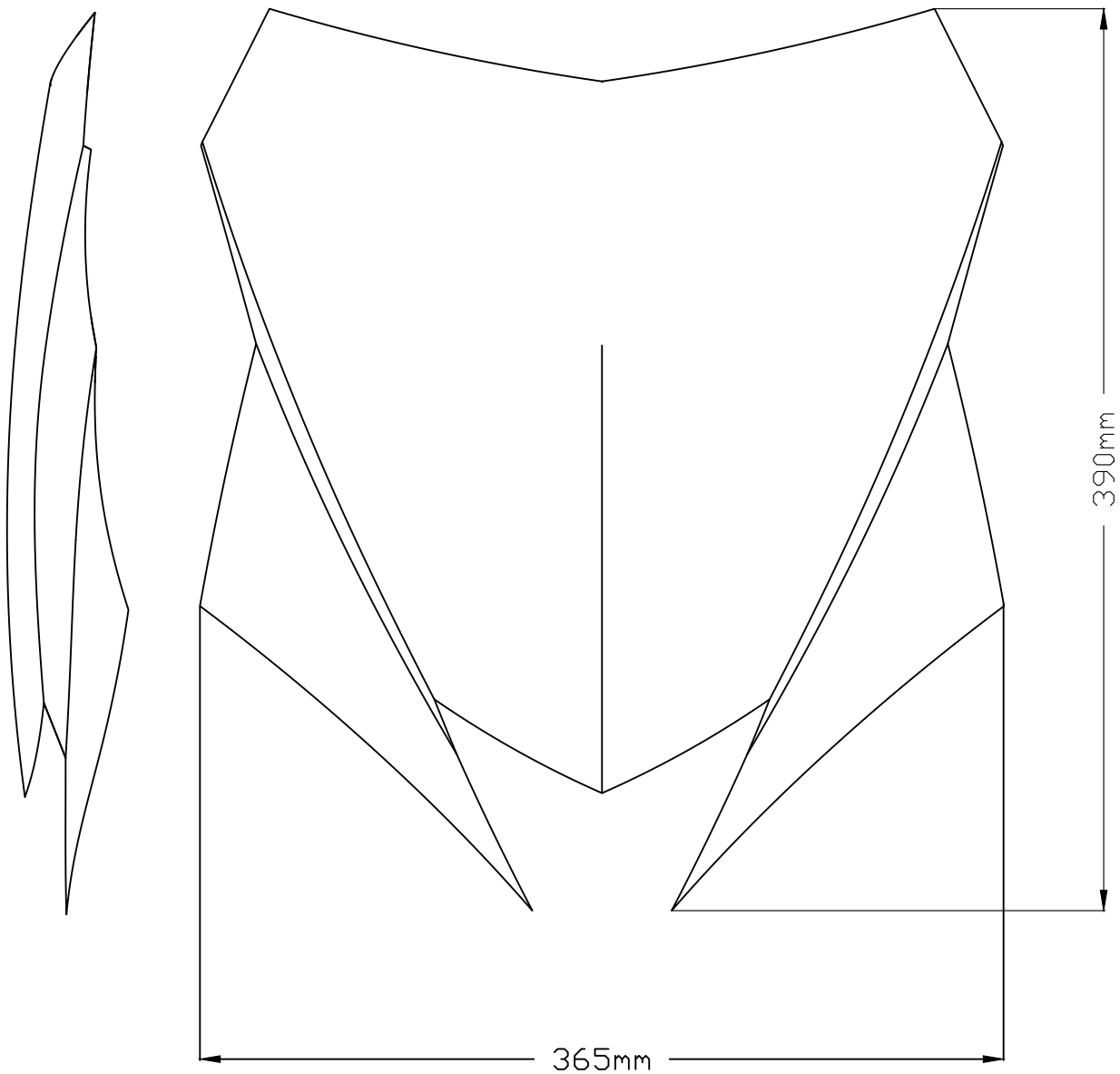

	PROJECT NAME: SPORT SCREEN FOR DUCATI MULTISTRADA V4 '21-	REF: 20729	
	Version:	DIN-A4	Hoja : 1/1
DRAWN BY: VANESA LUNA	Description: <p style="text-align: center;">VS3</p>	MATERIAL: CN 4	THICKNESS: 4 mm
DATE: 14/05/2021		VISOR: /	DEFLECTOR: /
SCALE: 1:3		DIFFERENCE TO ORIGINAL: - 90 mm	
		DEFLECTOR FOR OEM SCREEN : /	

TOURING SCREEN WITH VISOR AT LOWER POSITION

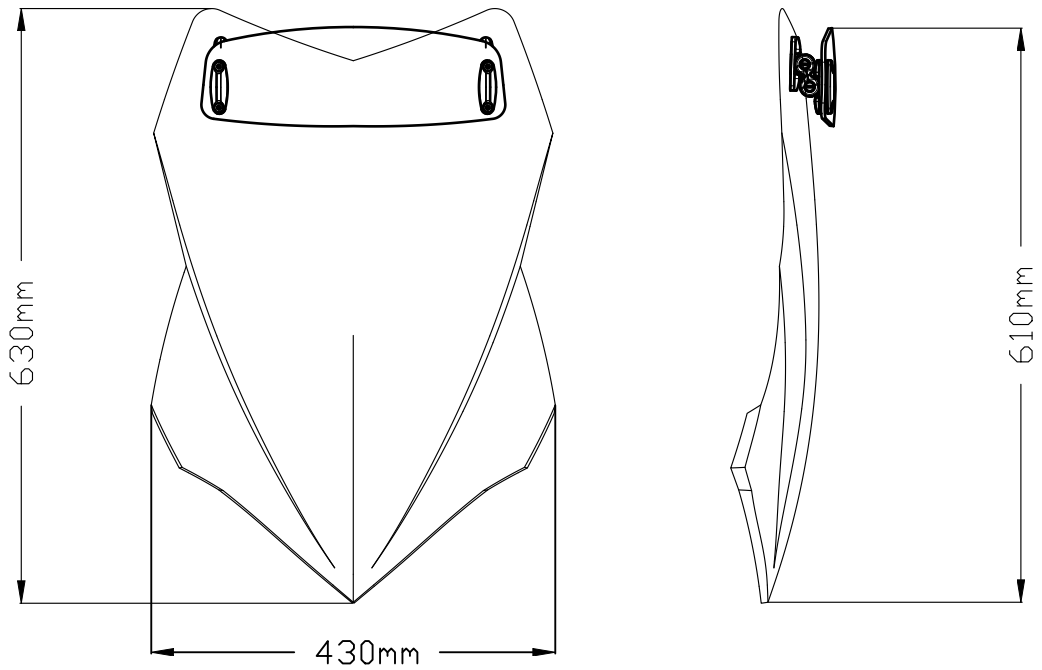

TOURING SCREEN WITH VISOR AT UPPER POSITION

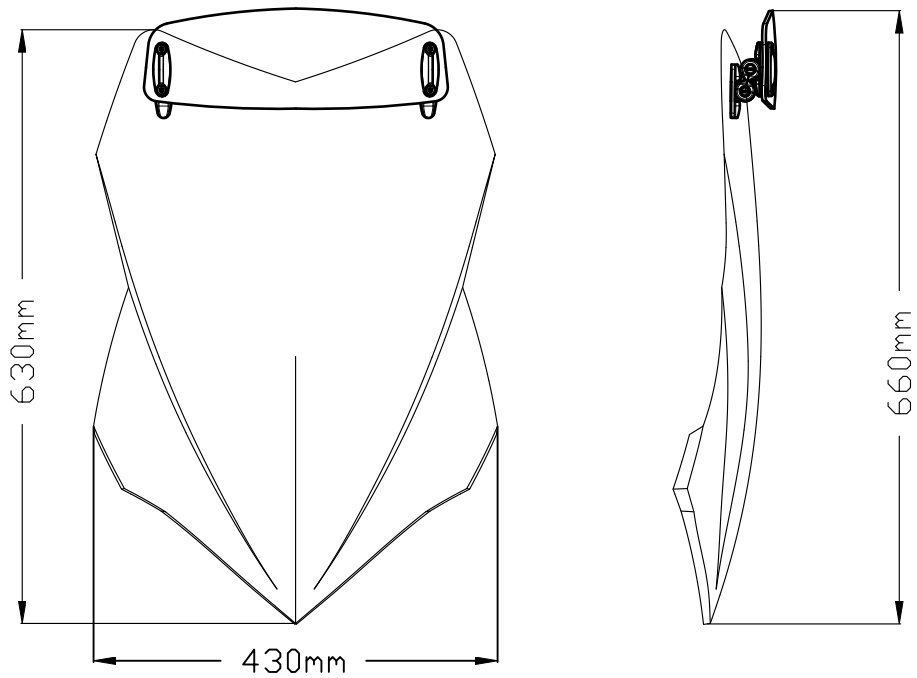

S22 38182*26

	<p>PROJECT NAME: TOURING SCREEN WITH VISOR FOR DUCATI MULTISTRADA V4 '21-</p>	<p>REF: 20733</p>	
	<p>Version:</p>	<p>DIN-A4</p>	<p>Hoja : 1/1</p>
<p>DRAWN BY: VANESA LUNA</p>	<p>Description:</p> <p style="text-align: center;">VS2.3</p>	<p>MATERIAL: CN</p>	
<p>DATE: 14/05/2021</p>		<p>THICKNESS: 4mm</p>	
<p>SCALE: 1/8</p>		<p>VISOR Nº: 3</p>	
		<p>VISOR FOR OEM SCREEN: /</p>	

S22 38182*26

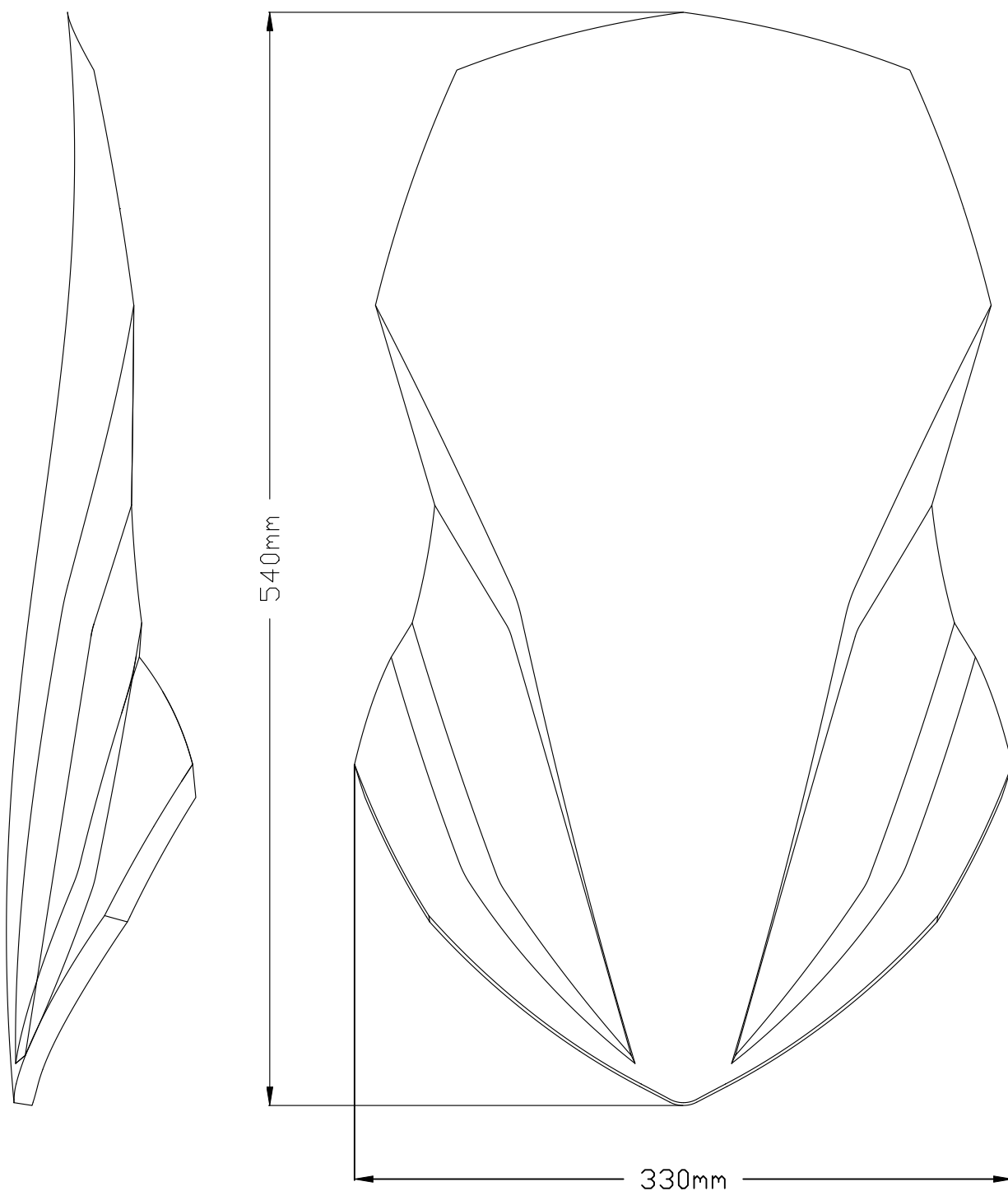

	PROJECT NAME: TOURING SCREEN FOR HONDA NC750X '21-	REF: 20752		
	Version:	DIN-A4	Hoja : 1/1	
DRAWN BY: VANESA LUNA	Description: <p style="text-align: center;">VS2</p>	MATERIAL: CN 4	THICKNESS: 4 mm	
DATE: 26/06/2021		VISOR: nº 2	DEFLECTOR: /	
SCALE: 1:3		DIFFERENCE TO ORIGINAL: +110mm		
		DEFLECTOR FOR OEM SCREEN : /		

TOURING SCREEN WITH VISOR AT LOWER POSITION

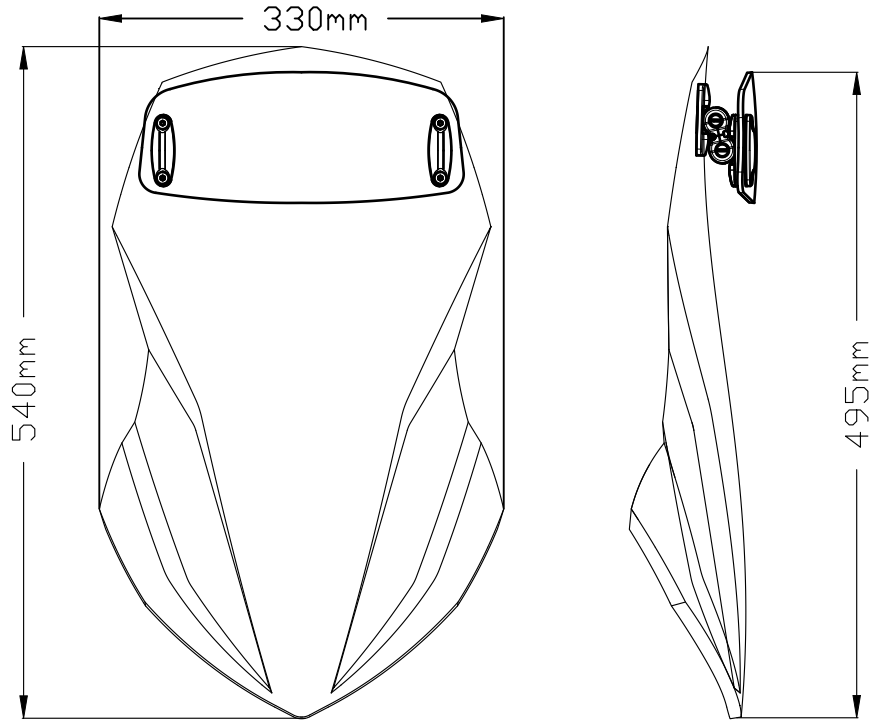

TOURING SCREEN WITH VISOR AT UPPER POSITION

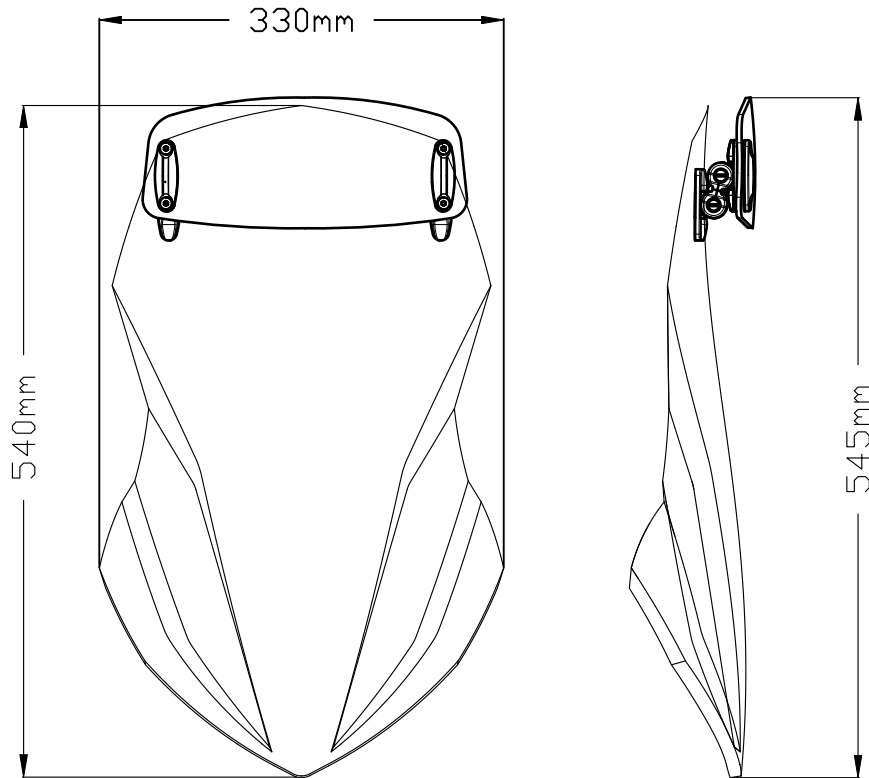

S22 38182*26

	<p>PROJECT NAME: TOURING SCREEN WITH VISOR FOR HONDA NC750X '21-</p>	<p>REF: 20753</p>	
	<p>Version:</p>	<p>DIN-A4</p>	<p>Hoja : 1/1</p>
<p>DRAWN BY: VANESA LUNA</p>	<p>Description:</p> <p style="text-align: center;">VS2.2</p>	<p>MATERIAL: CN</p>	
<p>DATE: 21/06/2021</p>		<p>THICKNESS: 4mm</p>	
<p>SCALE: 1/6</p>		<p>VISOR N°: 2</p> <p>VISOR FOR OEM SCREEN: /</p>	

S22 38182*26

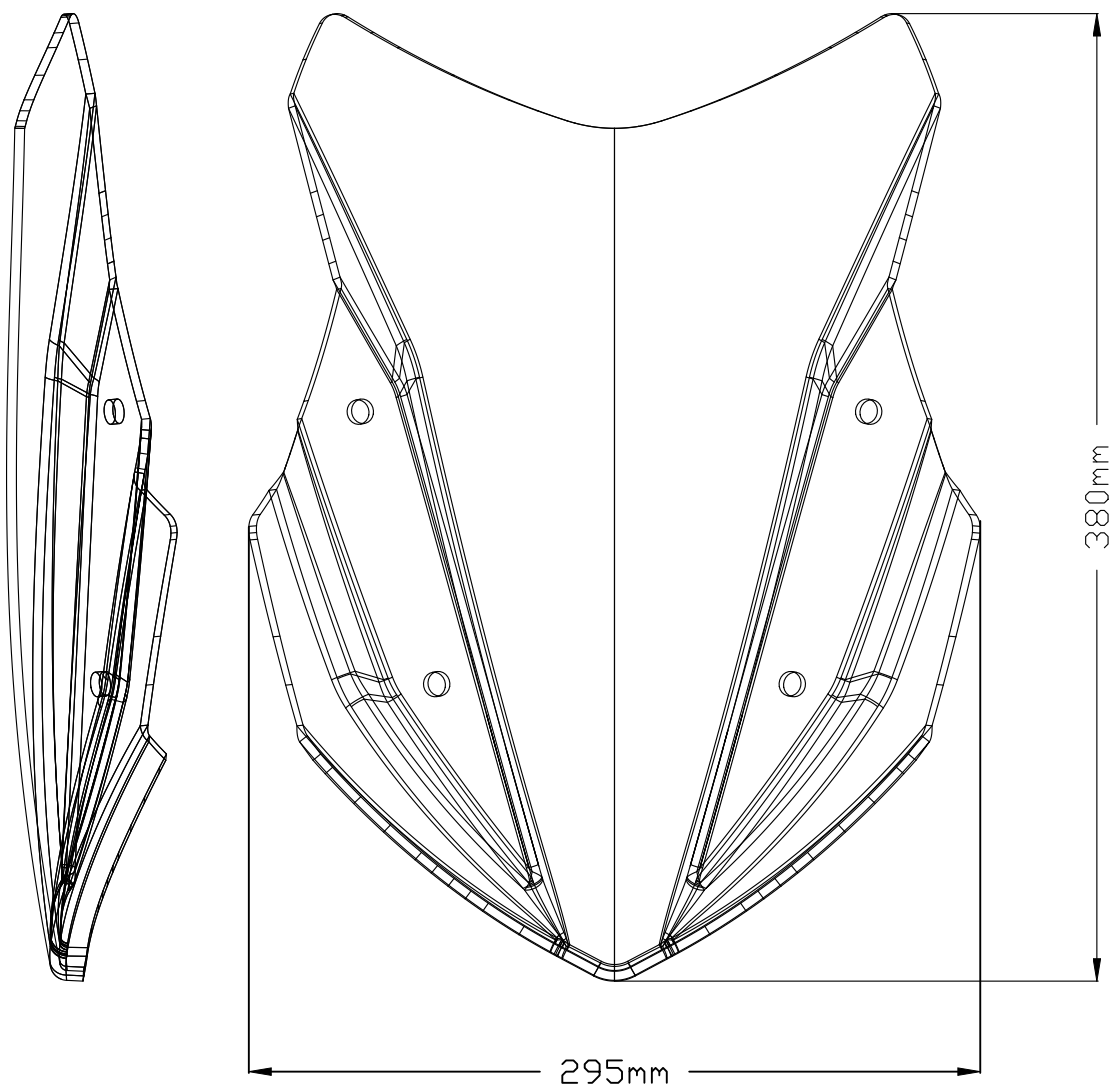

	PROJECT NAME: SPORT SCREEN FOR HONDA NC750X '21-	REF: 20773		
	Version:	DIN-A4	Hoja : 1/1	
DRAWN BY: VANESA LUNA	Description: <p style="text-align: center;">VS3</p>	MATERIAL: CN 4	THICKNESS: 4 mm	
DATE: 05/07/2021		VISOR: nº 1 CLIP-ON		
SCALE: 1:3		DIFFERENCE TO ORIGINAL: -30mm		
		DEFLECTOR FOR OEM SCREEN : nº1 CLIP-ON		

S22 38182*26

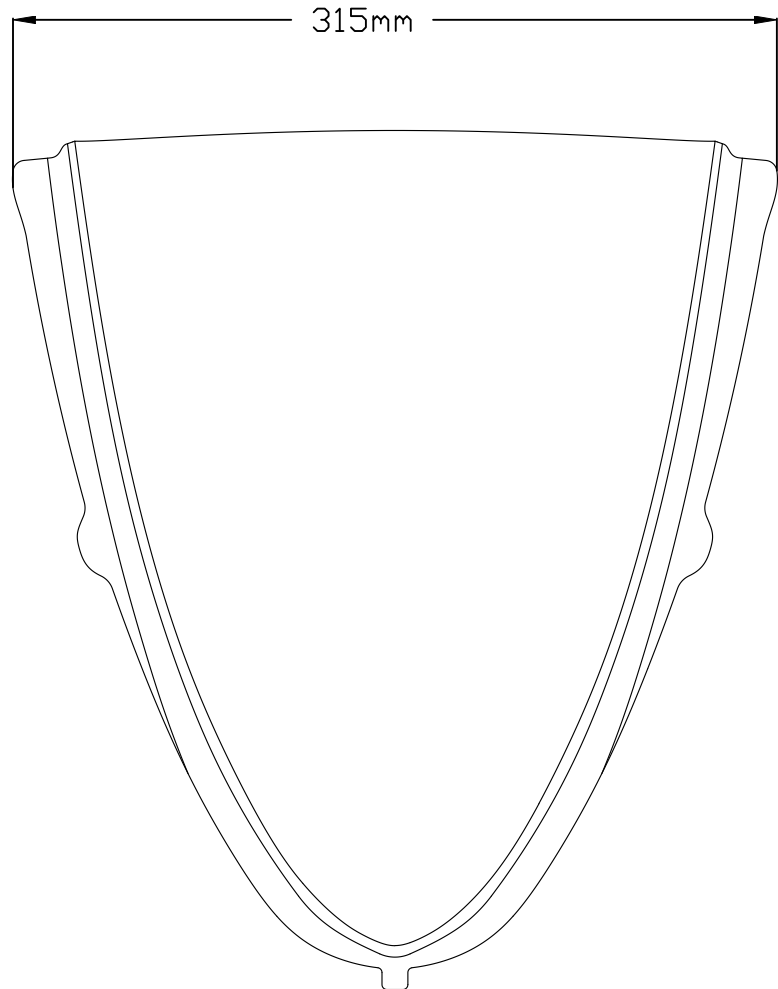
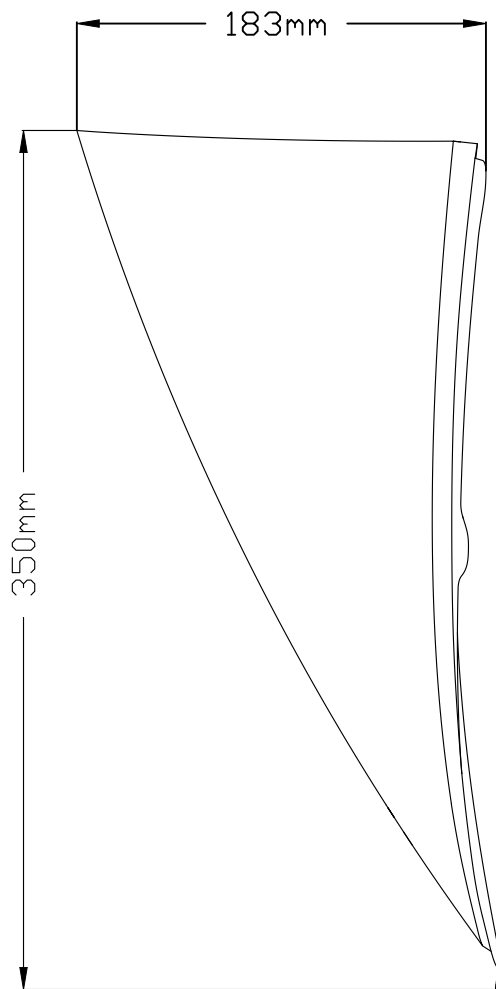

	PROJECT NAME: R-RACER SCREEN FOR APRILIA RSV4 '21-	REF: 20771	
	Version:	DIN-A4	Hoja : 1/1
DRAWN BY: VANESA LUNA	Description: VS3	MATERIAL: CI 30	THICKNESS: 3mm
DATE: 21/12/2021		VISOR: 4835 / 4837	
SCALE: 1/3		VISOR FOR OEM SCREEN : /	
		DIFERENCE TO ORIGINAL SCREEN: +60mm	

S22 38182*26

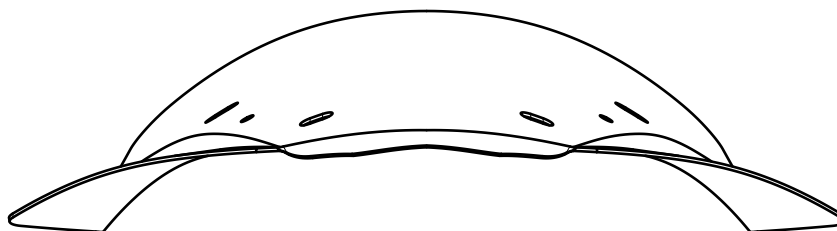
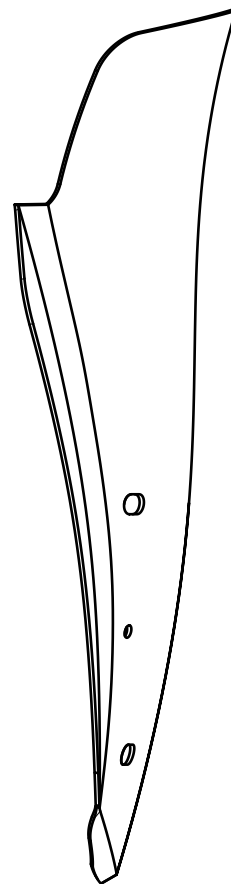
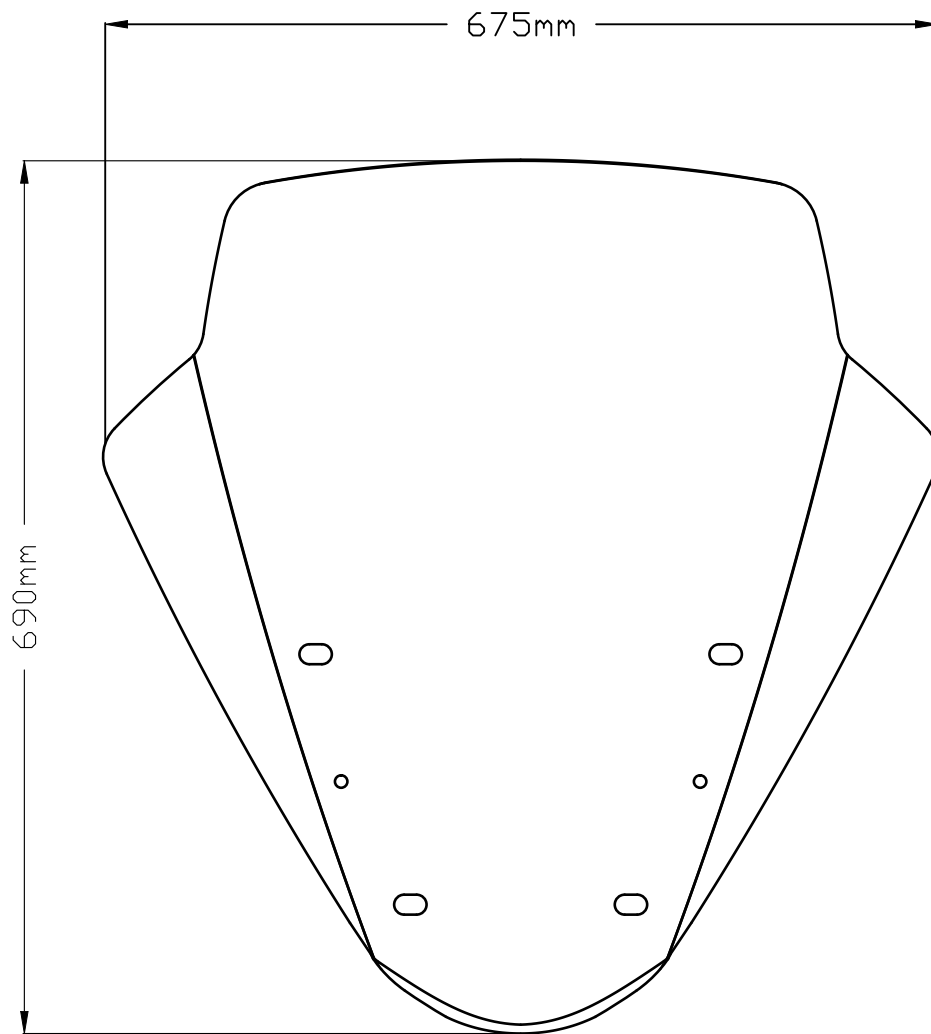

	PROJECT NAME: TOURING SCREEN FOR BMW R1250RT '21-	REF: 20774	
	Version:	DIN-A4	Hoja : 1/1
DRAWN BY: VANESA LUNA	Description: <p style="text-align: center;">VS2</p>	MATERIAL: CN 4	THICKNESS: 4 mm
DATE: 25/06/2021		VISOR: nº 3	DEFLECTOR: /
SCALE: 1:6		DIFFERENCE TO ORIGINAL: +80mm	
		VISOR FOR OEM SCREEN : nº 3	

TOURING SCREEN WITH VISOR AT LOWER POSITION

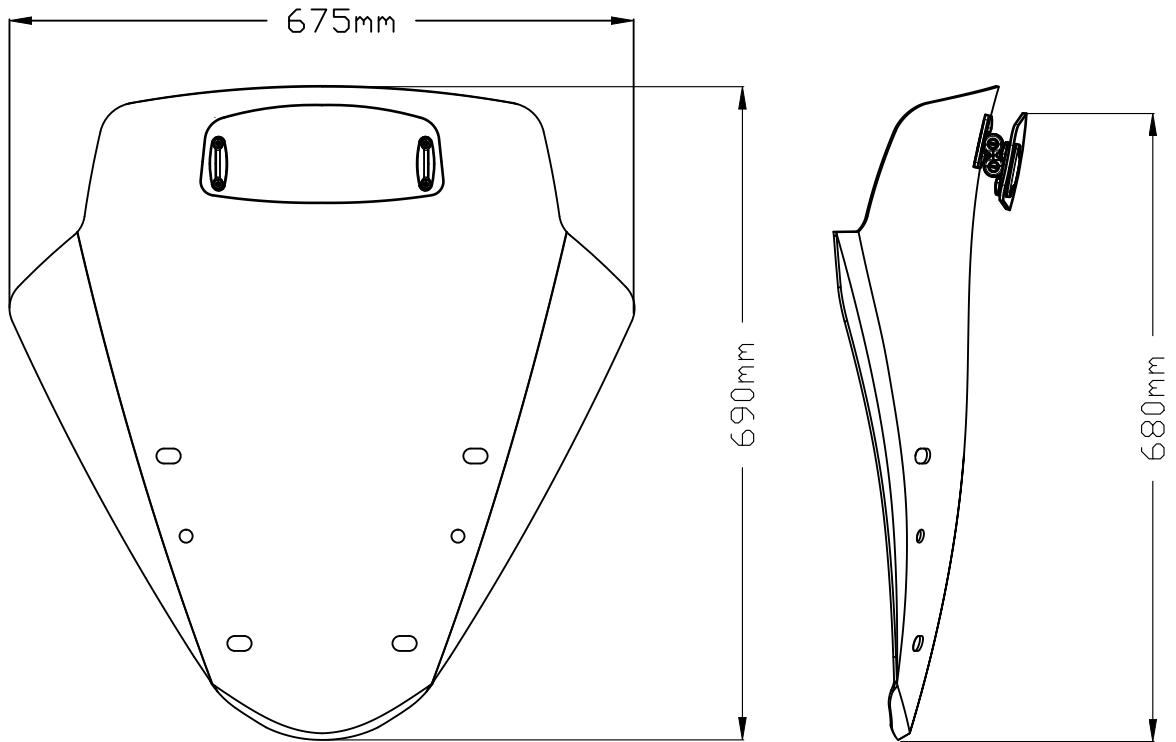

TOURING SCREEN WITH VISOR AT UPPER POSITION

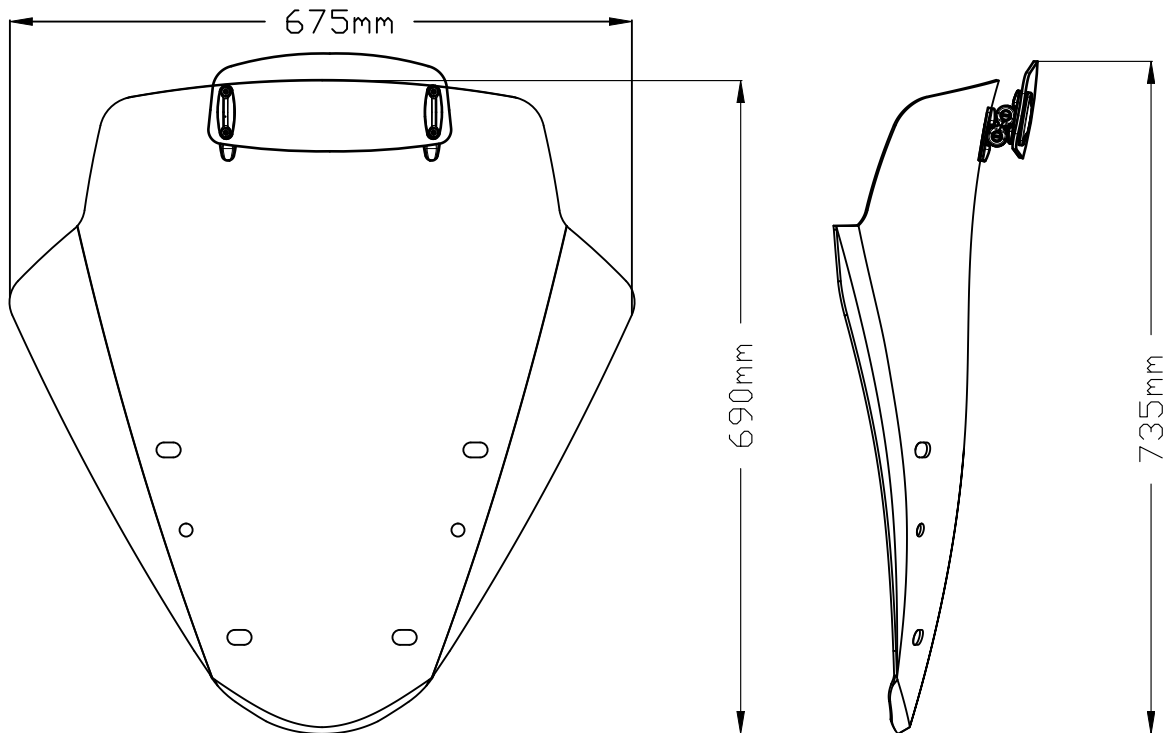

S22 38182*26



PROJECT NAME:

TOURING SCREEN WITH VISOR
FOR BMW R1250RT '21-

REF: 20775

Version:

DIN-A4

Hoja : 1/1

DRAWN BY: VANESA LUNA

Description:

MATERIAL: CN

DATE: 25/06/2021

VS2.4

THICKNESS: 4mm

SCALE: 1/8

VISOR Nº: 3

VISOR FOR OEM SCREEN: nº 3

S22 38182*26

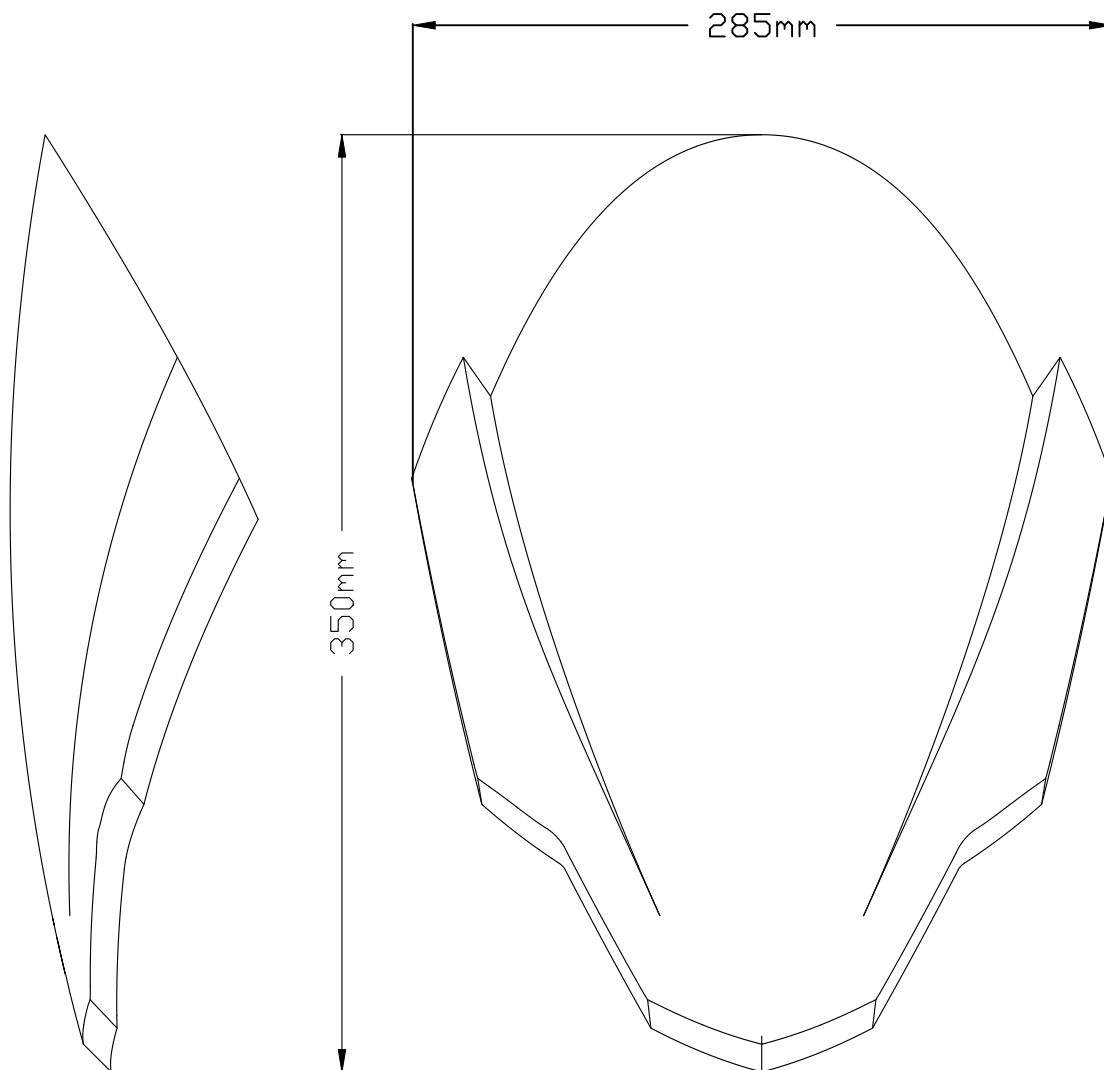

	PROJECT NAME: Z-RACING SCREEN FOR APRILIA TUONO 660 '21-	REF: 20794	
	Version:	DIN-A4	Hoja : 1/1
DRAWN BY: VANESA LUNA	Description: VS3	MATERIAL: CI 30	
DATE: 30/07/2021		THICKNESS: 3 mm	
SCALE: 1:3		DIFFERENCE TO ORIGINAL SCREEN: +55 mm	

S22 38182*26

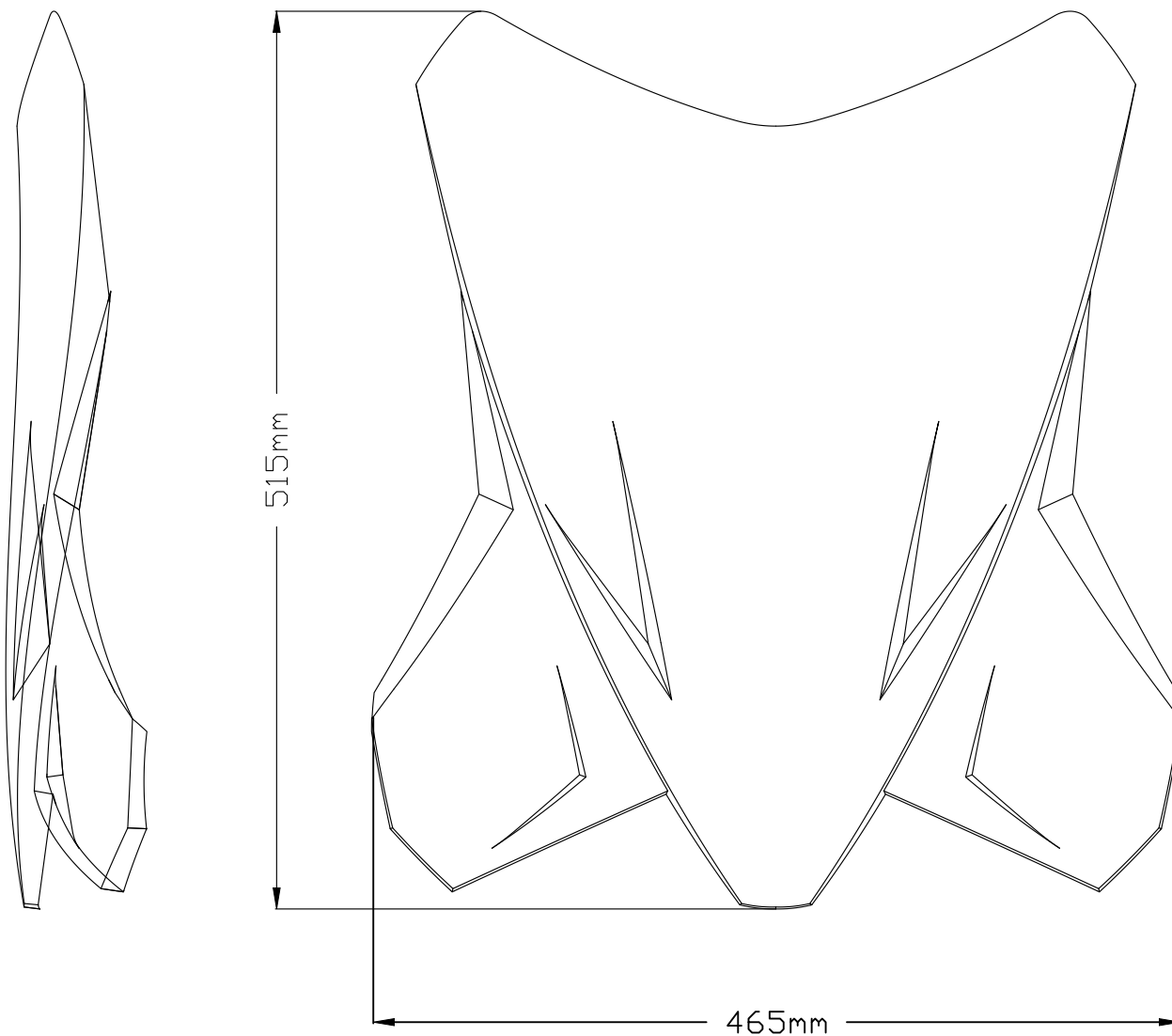

	PROJECT NAME: TOURING PLUS SCREEN FOR KTM 1290 SUPERADVENTURE R/S '21-	REF: 20816	
	Version:	DIN-A4	Hoja : 1/1
DRAWN BY: VANESA LUNA	Description: VS2	MATERIAL: CN 4	THICKNESS: 4mm
DATE: 06/09/2021		VISOR :MULTI-ADJUSTABLE VISOR 2.0	
SCALE: 1:4		DIFFERENCE TO OEM SCREEN: +130mm	

TOURING SCREEN WITH VISOR AT LOWER POSITION

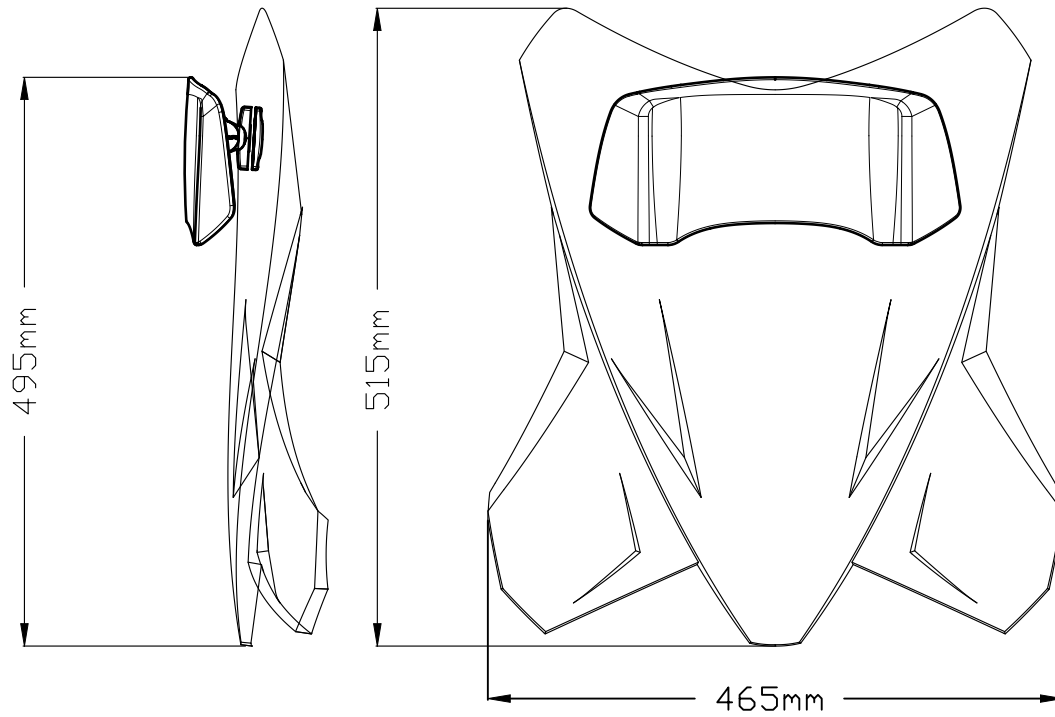

TOURING SCREEN WITH VISOR AT UPPER POSITION

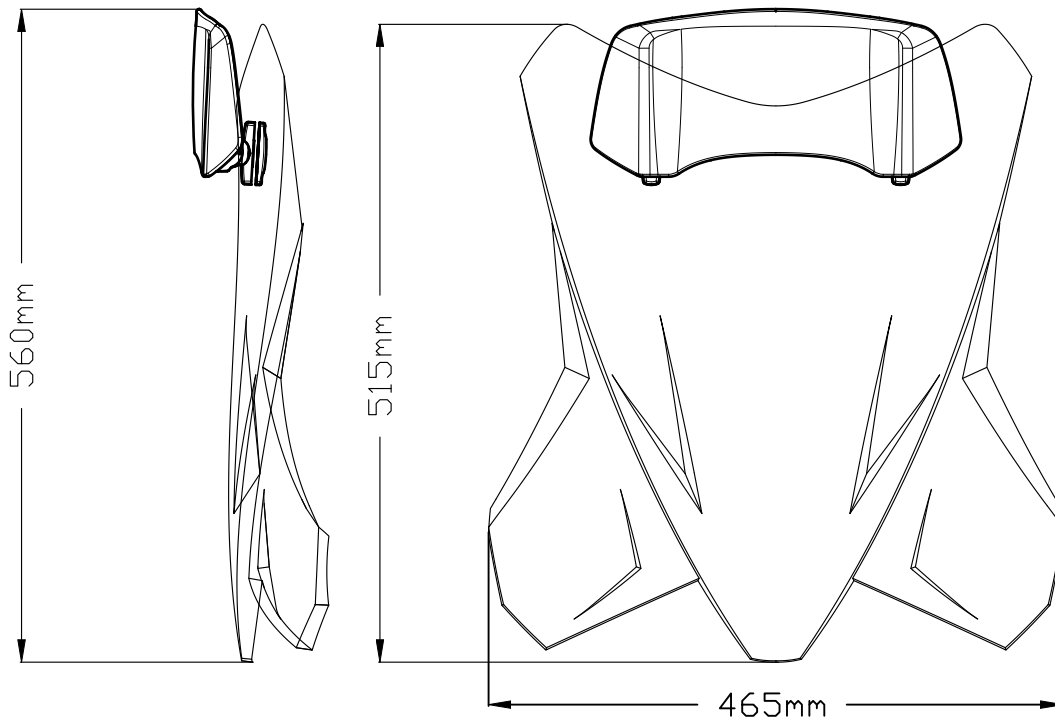

S22 38182*26

	<p>PROJECT NAME: TOURING PLUS SCREEN WITH FOR KTM 1290 SUPERADVENTURE R/S '21-</p>	<p>REF: 20817</p>	
	<p>Version:</p>	<p>DIN-A4</p>	<p>Hoja : 1/1</p>
<p>DRAWN BY: VANESA LUNA</p>	<p>Description:</p> <p style="text-align: center;">VS2.4</p>	<p>MATERIAL: CN 4</p>	<p>THICKNESS: 4mm</p>
<p>DATE: 06/09/2021</p>		<p>VISOR :MULTI-ADJUSTABLE VISOR 2.0</p>	
<p>SCALE: 1:4</p>		<p>DIFFERENCE TO OEM SCREEN: +130mm</p>	

S22 38182*26

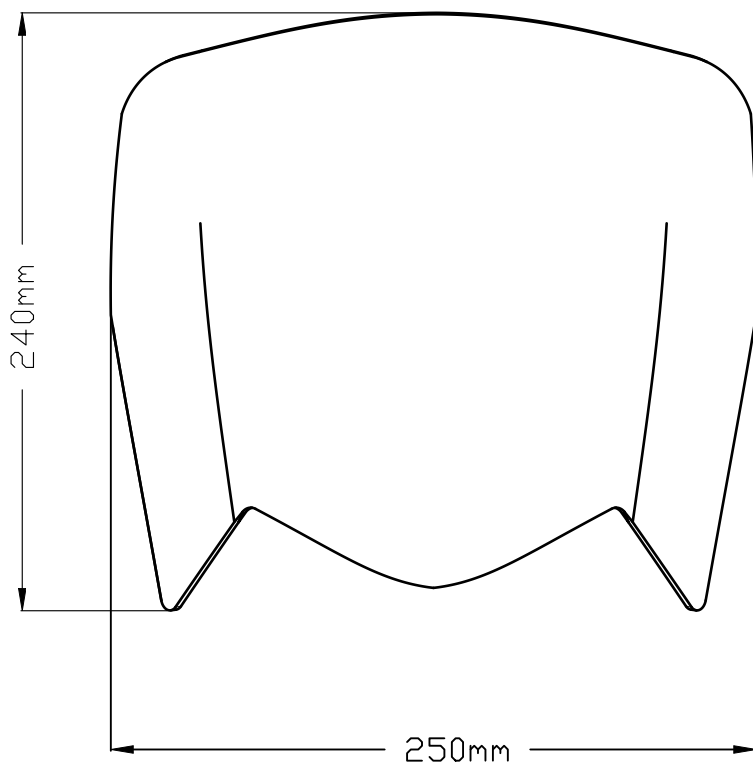

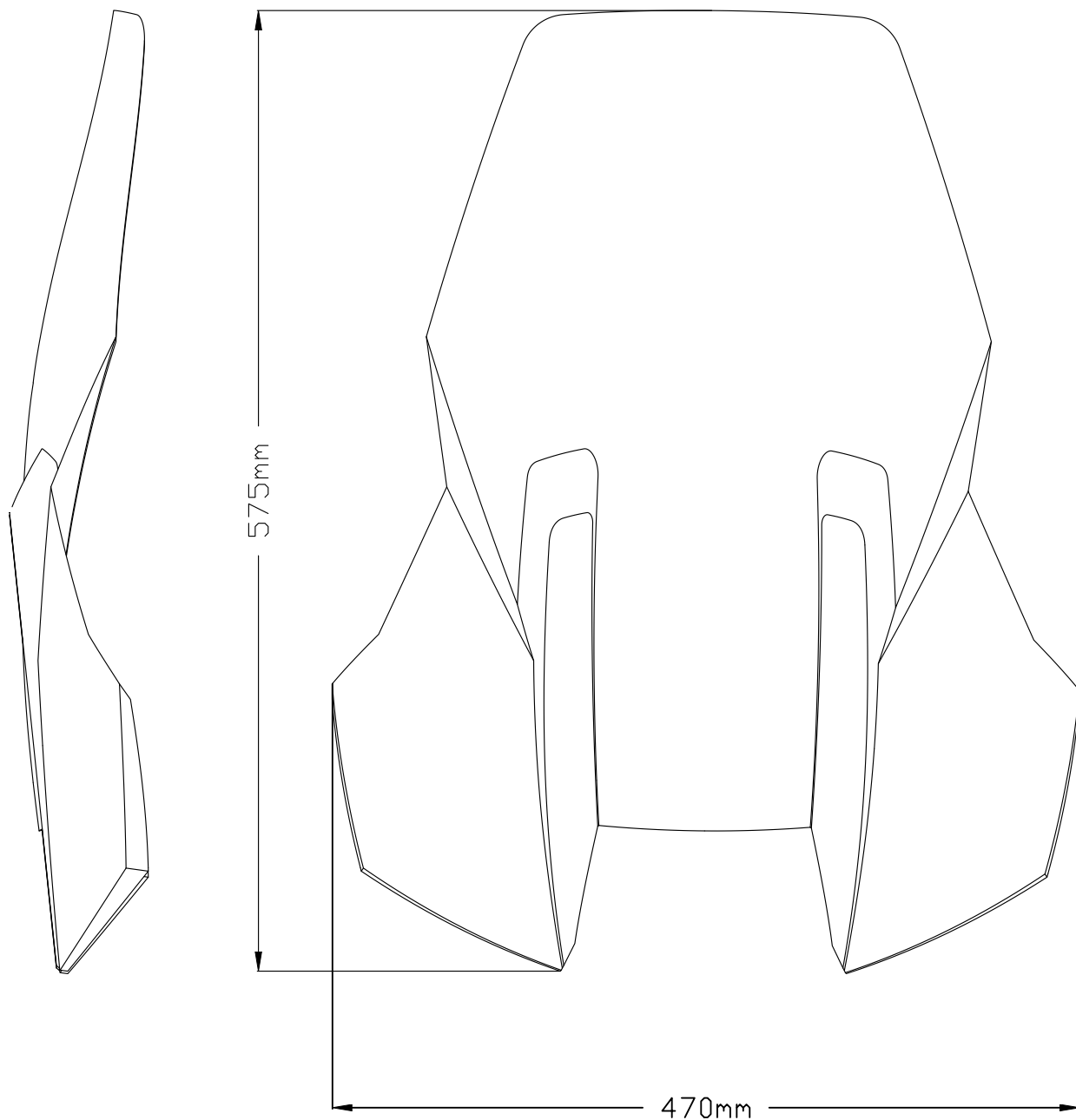

	PROJECT NAME: SPORT SCREEN FOR YAMAHA TENERE 700 '19-	REF: 20834	
	Version:	DIN-A4	Hoja : 1/1
DRAWN BY: VANESA LUNA	Description: <p style="text-align: center;">VS3</p>	MATERIAL: CI 30	THICKNESS: 3mm
DATE: 24/09/2021		VISOR: /	
SCALE: 1/3		VISOR FOR OEM SCREEN : /	
		DIFFERENCE TO ORIGINAL SCREEN : -50 mm	

S22 38182*26



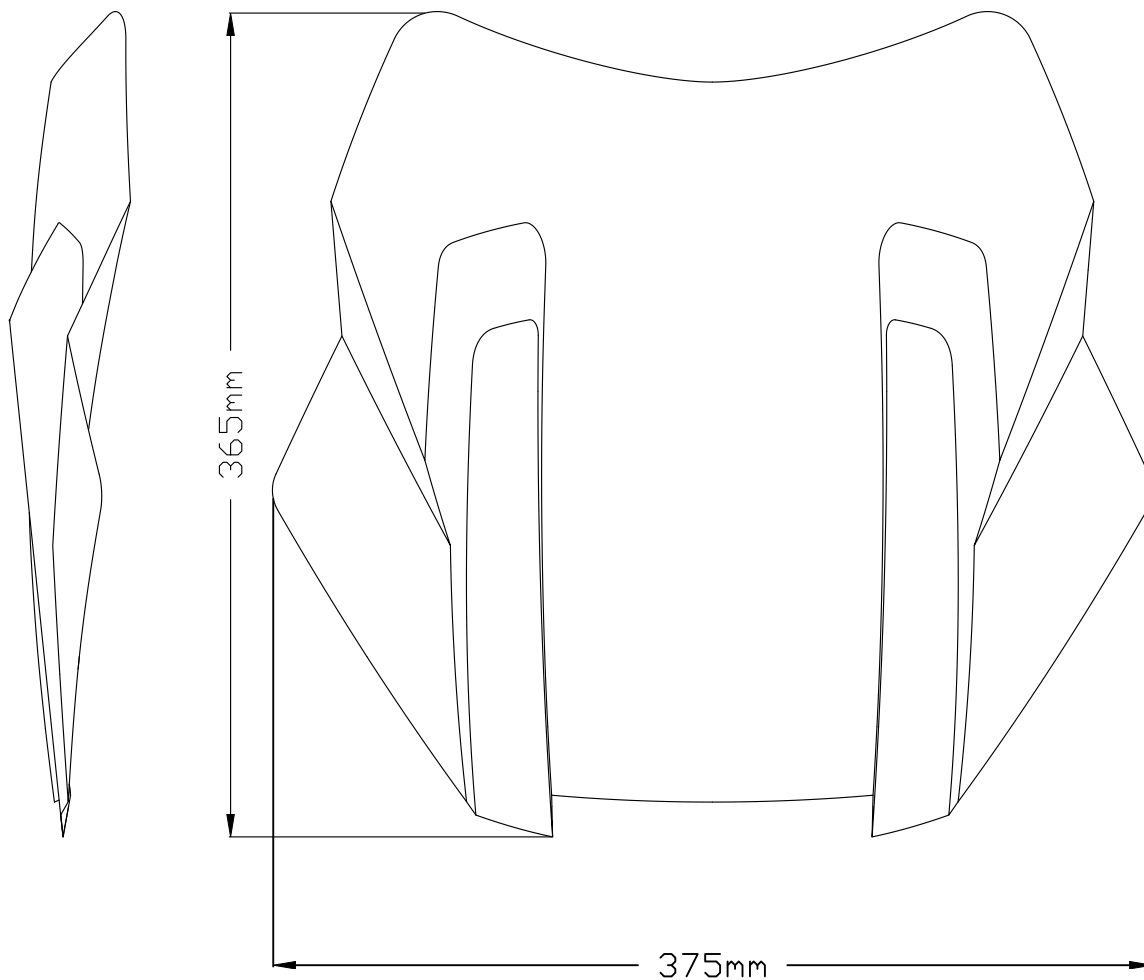

	PROJECT NAME: TOURING SCREEN FOR HARLEY DAVIDSON 1250 PAN AMERICA '21-	REF: 20840	
	Version:	DIN-A4	Hoja : 1/1
DRAWN BY: VANESA LUNA	Description: VS2	MATERIAL: CN 4	THICKNESS: 4 mm
DATE: 21/02/2022		VISOR: NO	DEFLECTOR:
SCALE: 1:4		DIFFERENCE TO ORIGINAL SCREEN: +70mm	
		DEFLECTOR FOR OEM SCREEN : 20765	

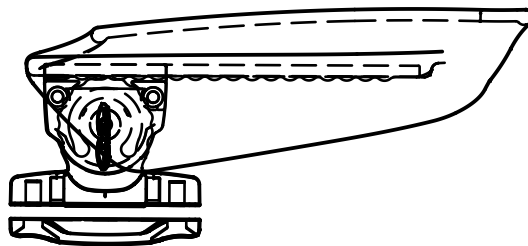
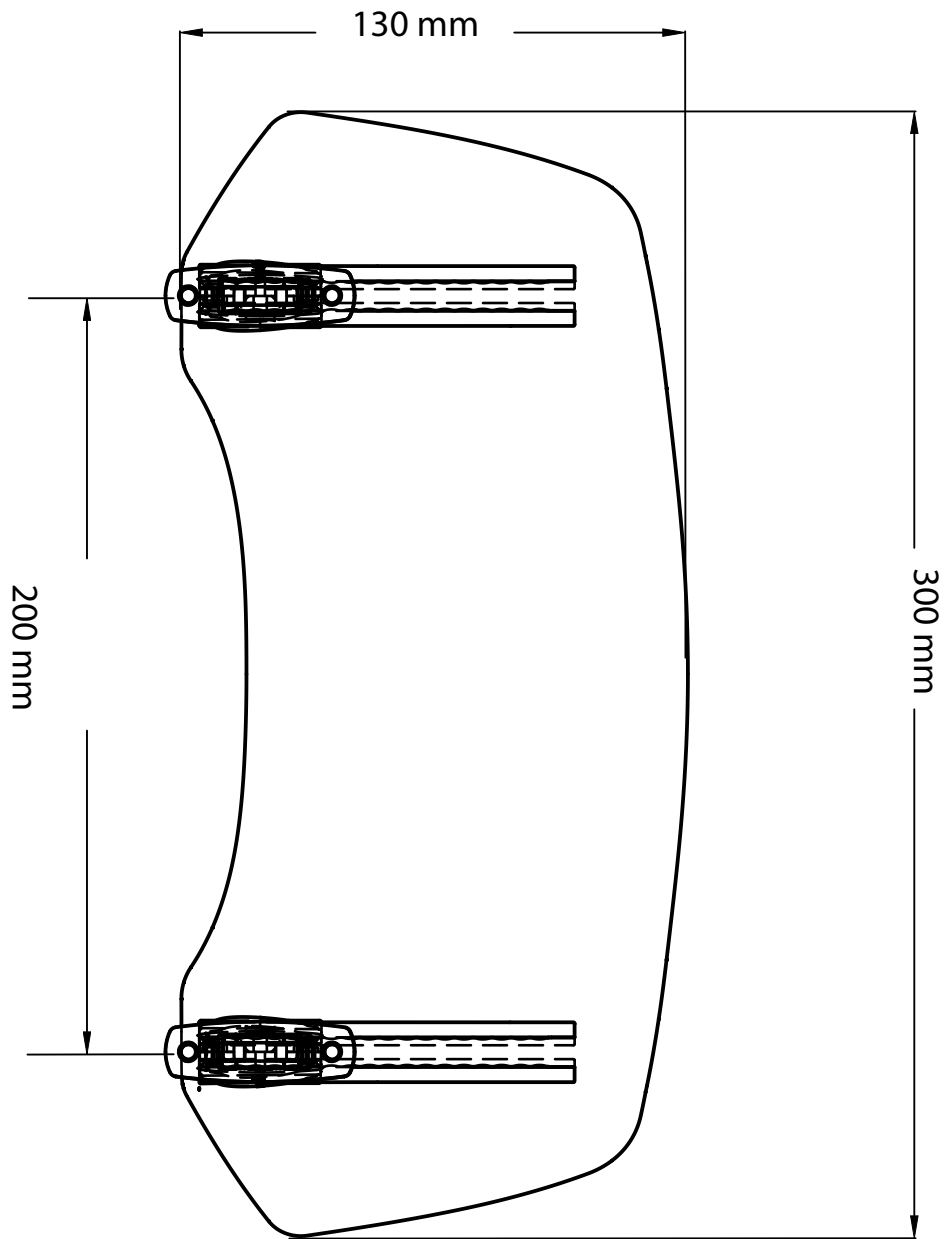

	PROJECT NAME: SPORT SCREEN FOR HARLEY DAVIDSON 1250 PAN AMERICA '21-	REF: 20841		
	Version:	DIN-A4	Hoja : 1/1	
DRAWN BY: VANESA LUNA	Description: <div style="text-align: center; font-size: 24px; font-weight: bold;">VS3</div>	MATERIAL: CN 4	THICKNESS: 4 mm	
DATE: 21/02/2022		VISOR: N°2	DEFLECTOR:	
SCALE: 1:3		DIFFERENCE TO ORIGINAL SCREEN: -45mm	DEFLECTOR FOR OEM SCREEN : 20765	
		DEFLECTOR FOR OEM SCREEN : 20765	DEFLECTOR FOR OEM SCREEN : 20765	

S22 38182*26



	PROJECT NAME: MULTI-ADJUSTABLE 2.0 VISOR- FIX	REF: 20763	
	Version:	DIN-A4	Hoja : 1/1
DRAWN BY: VANESA LUNA	Description: Aufsatz nº4	stroke : 70mm	
DATE: 18/11/2021			
SCALE: 1:2			

YAMAHA TRACER 900 '18- / 900GT '18-

REF 3762

CÚPULA TOURING PARA / TOURING SCREEN FOR / TOURENSCHEIBE FÜR

Typ: VS2



1 Person



15 min



EASY



PHILLIPS





ALLEN



Nº 3

S22 38182*26

ID.	PIEZA / PART	DESCRIPCIÓN	DESCRIPTION	QTY.	REF.:
1		Cúpula touring	Touring Screen	1	3762F/H/WM3
2		Silentblock Ø9xØ6x8mm	Ø9xØ6x8mm silentblock	4	AROPASACABLES-3
3		Casquillo con valona Ø12xØ6,8x7,3	Ø12xØ6,8x7,3 bush with flange	4	CASQUI-1A---750
4		Tornillo M5x25 Ø11 ISO7380	M5x25 Ø11 ISO7380 allen screw	4	TORNI-I7380-766
5		Tapón M5 ISO7380	M5 ISO7380 screw cap	4	TAPON-----85

YAMAHA TRACER 900 '18- / 900GT '18-

INSTRUCCIONES DE MONTAJE - MOUNTING INSTRUCTIONS - MONTAGEANLEITUNG

1

**DISASSEMBLY
DESMONTAJE**

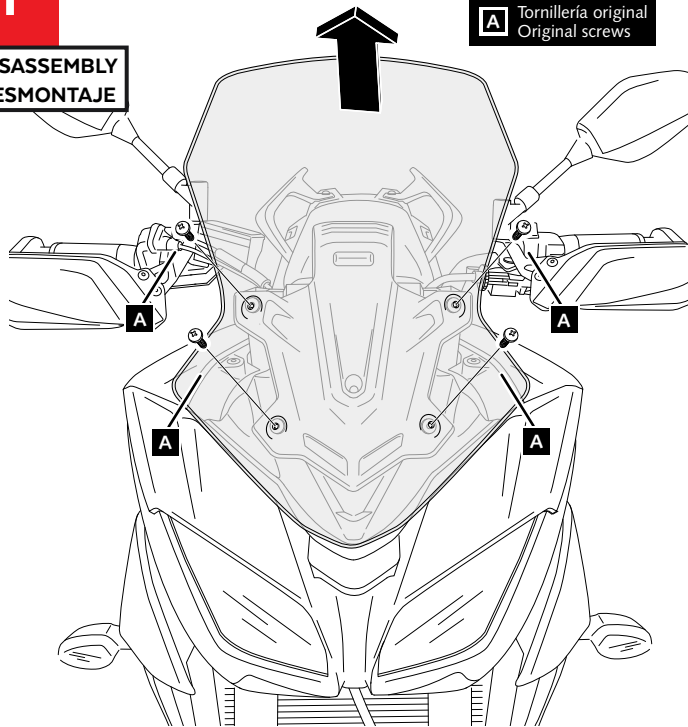

2

**ASSEMBLY
MONTAJE**

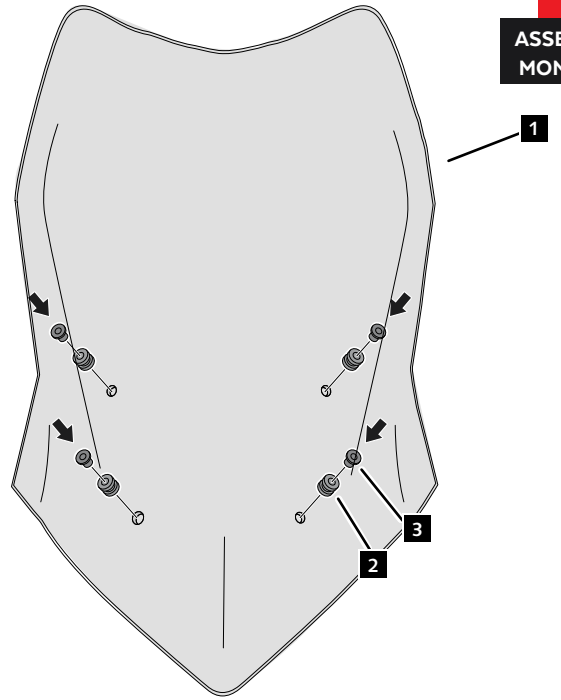

3

**ASSEMBLY
MONTAJE**

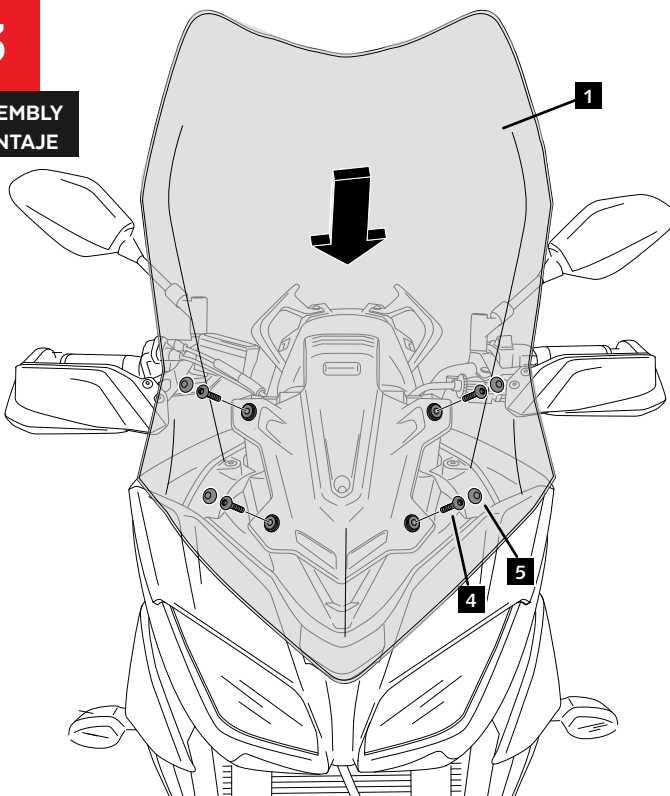

4

**ASSEMBLY
MONTAJE**

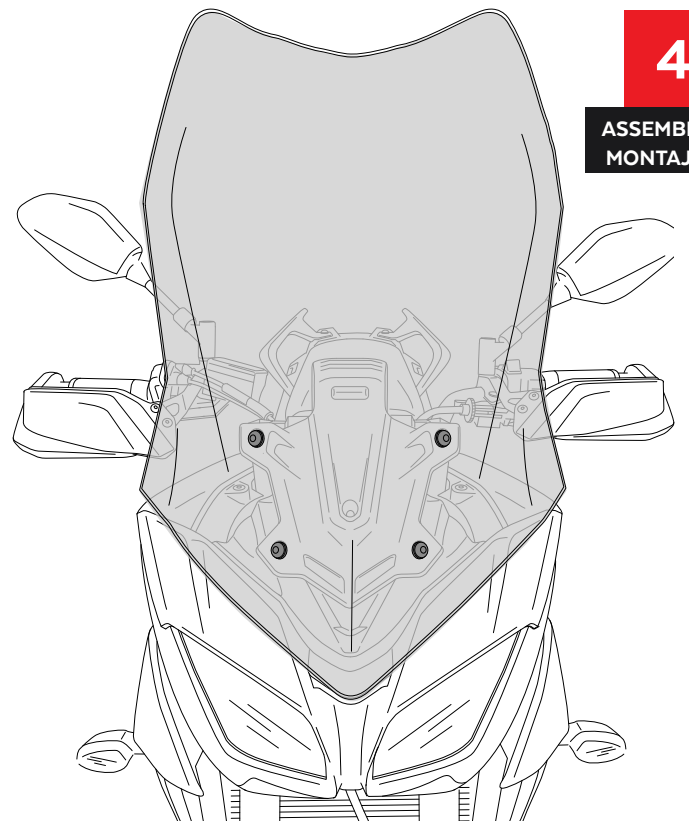

S22 38182*26

KTM 1290 SUPERADVENTURE R/S '21-

M O U N T I N G I N S T R U C T I O N S

REF 20401

SPORT SCREEN

Typ: VS3

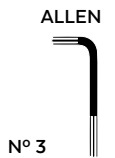

S22 38182*26

ID.	PIEZA/PART	DESCRIPCIÓN	DESCRIPTION	QTY.	REF.:
1		Cúpula SPORT	SPORT screen	1	20401W/H/F/NM3
2		Tornillo especial M5x8 Long Hexagonal 25 (Rosca int M5x20)	M5x8 special screw hexagonal Lenght 25	2	TORNI-EM5---732
3		Tornillo especial M5x8 Long Hexagonal 14 (Rosca int M5x13)	M5x8 special screw hexagonal Lenght 14	2	TORNI-EC----597
4		Silentblock Ø9 xØ6 x8mm	Ø12xØ6x9 Silentblock	4	AROPASACABLES-3
5		Casquillo con valona Ø12xØ6,8x7,3	Ø12xØ6,8x7,3 bush with flange	4	CASQUI-1A---750
6		Tornillo allen M5x16 Ø11 ISO 7380	M5x16 Ø11 ISO 7380 allen Screw	4	TORNI-I7380-493
7		Tapón tornillo M5 ISO 7380	M5 ISO7380 screw cap	4	TAPON-----85

* Algunos de los Componentes se suministran montados
Some components are supplied assembled

KTM 1290 SUPERADVENTURE R/S '21-

INSTRUCCIONES DE MONTAJE - MOUNTING INSTRUCTIONS - MONTAGEANLEITUNG

1

**DISASSEMBLY
DESMONTAJE**

A Tornillería original
Original screws

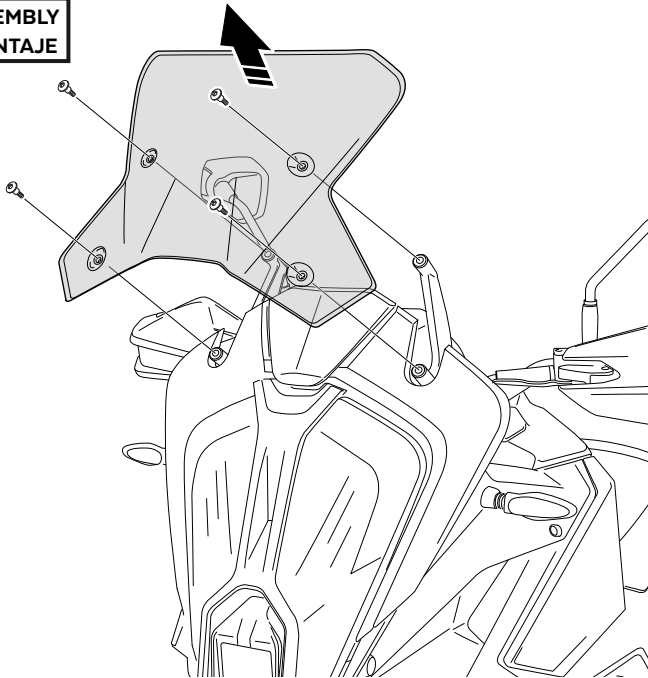

2

**ASSEMBLY
MONTAJE**

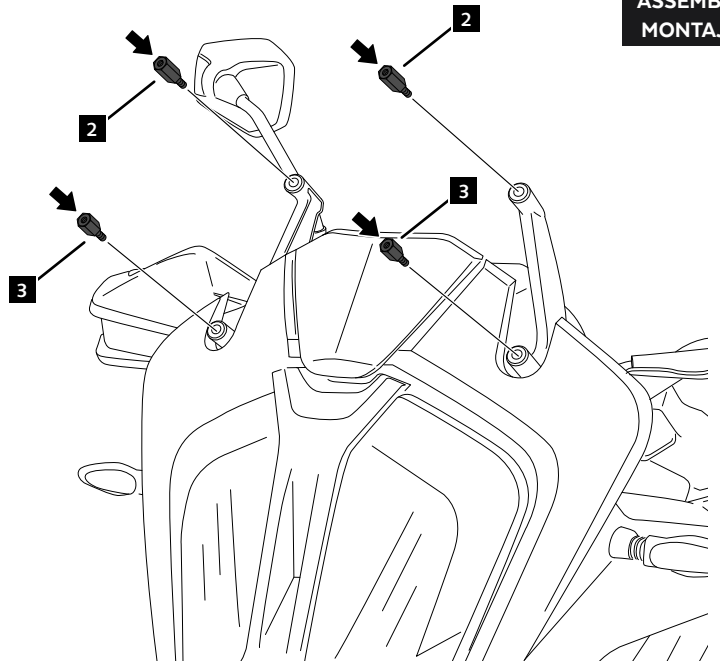

3

**ASSEMBLY
MONTAJE**

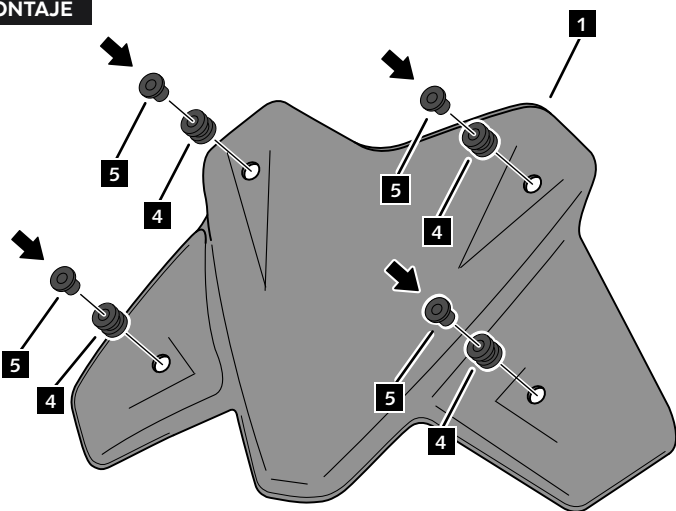

4

**ASSEMBLY
MONTAJE**

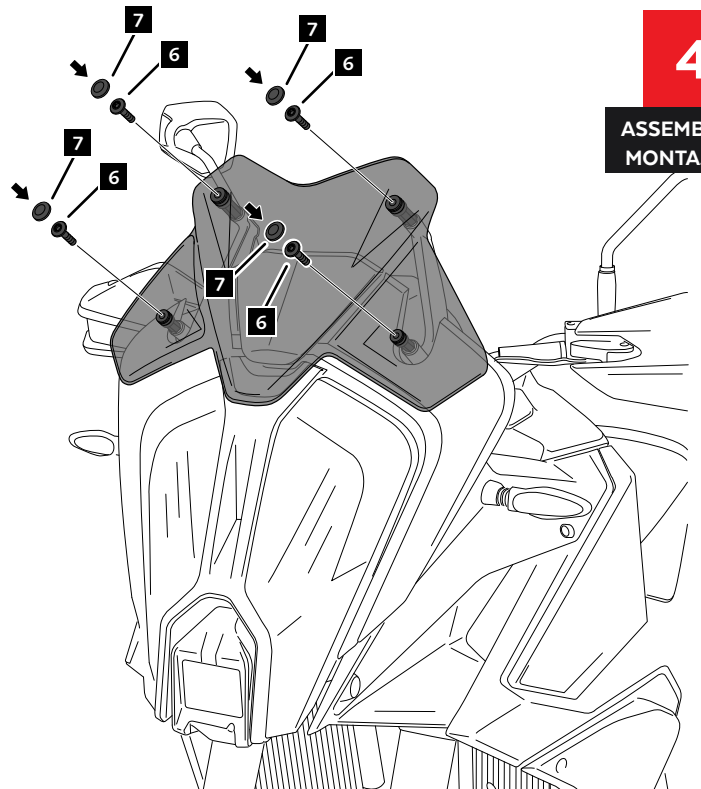

KTM 1290 SUPERADVENTURE R/S '21-

M O U N T I N G I N S T R U C T I O N S

REF 20422

TOURING SCREEN

Typ: VS2



S22 38182*26

ID.	PIEZA/PART	DESCRIPCIÓN	DESCRIPTION	QTY.	REF.:
1		Cúpula TOURING	TOURING screen	1	20422W/H/FM3
2		Tornillo especial M5x8 Long Hexagonal 25 (Rosca int M5x20)	M5x8 special screw hexagonal Lenght 25	2	TORNI-EM5---732
3		Tornillo especial M5x8 Long Hexagonal 14 (Rosca int M5x13)	M5x8 special screw hexagonal Lenght 14	2	TORNI-EC----597
4		Silentblock Ø9 xØ6 x8mm	Ø12xØ6x9 Silentblock	4	AROPASACABLES-3
5		Casquillo con valona Ø12xØ6,8x7,3	Ø12xØ6,8x7,3 bush with flange	4	CASQUI-1A---750
6		Tornillo allen M5x16 Ø11 ISO 7380	M5x16 Ø11 ISO 7380 allen Screw	4	TORNI-I7380-493
7		Tapón tornillo M5 ISO 7380	M5 ISO7380 screw cap	4	TAPON-----85

* Algunos de los Componentes se suministran montados
Some components are supplied assembled

KTM 1290 SUPERADVENTURE R/S '21-

INSTRUCCIONES DE MONTAJE - MOUNTING INSTRUCTIONS - MONTAGEANLEITUNG

1

**DISASSEMBLY
DESMONTAJE**

A Tornillería original
Original screws

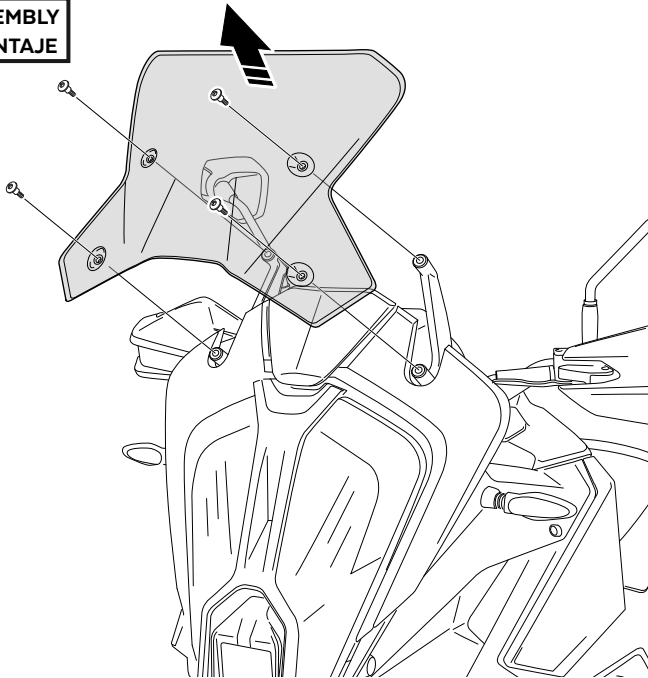

2

**ASSEMBLY
MONTAJE**

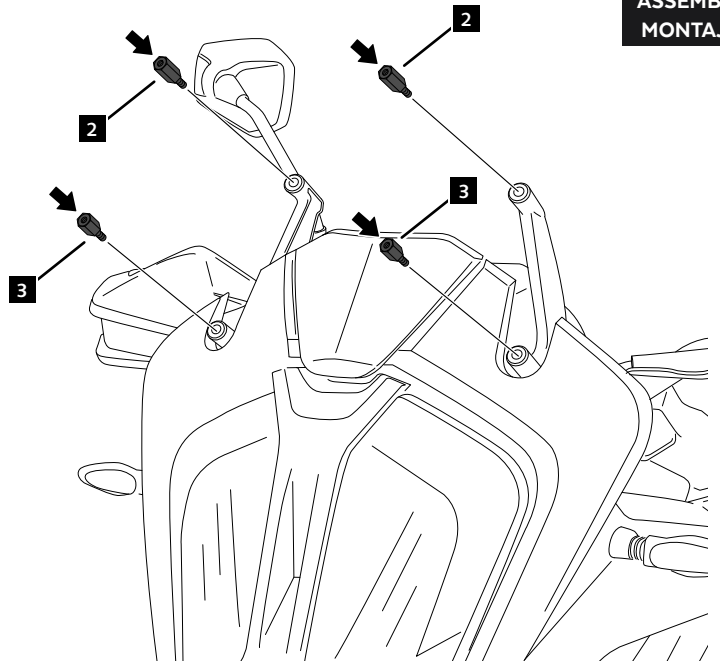

3

**ASSEMBLY
MONTAJE**

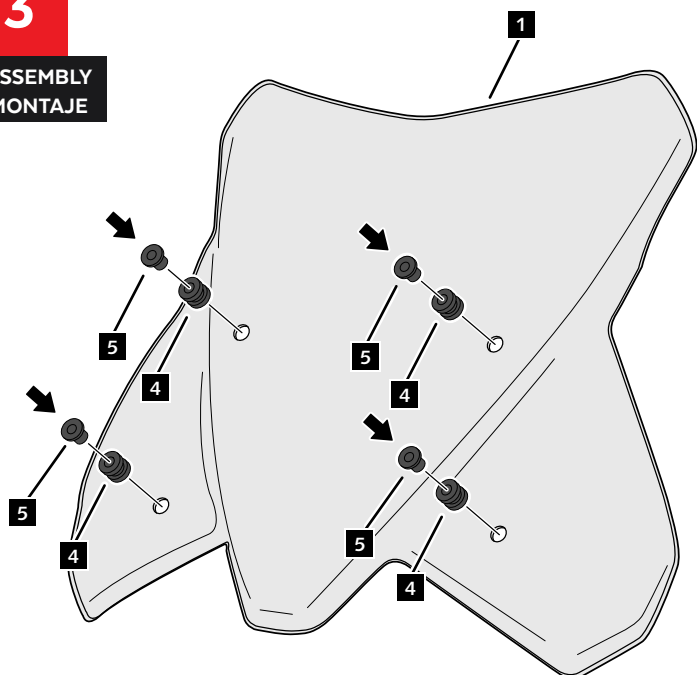

4

**ASSEMBLY
MONTAJE**

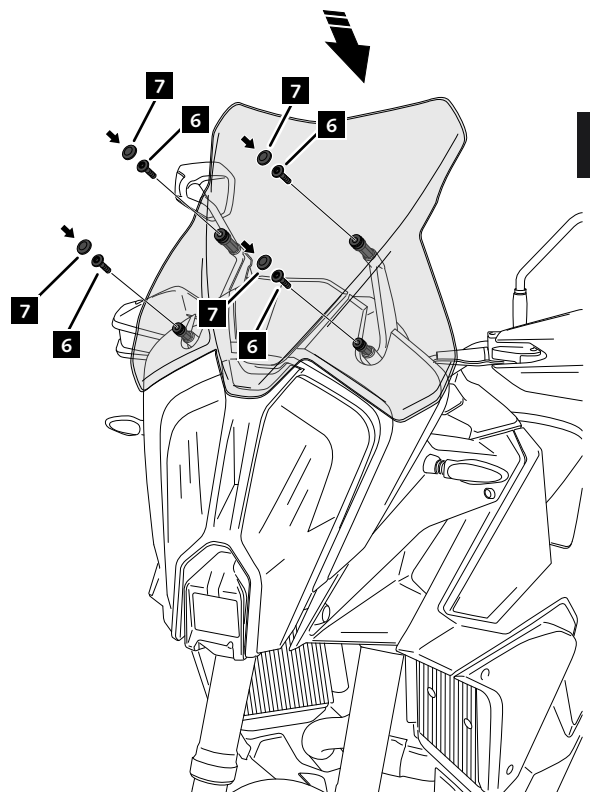

DUCATI MULTISTRADA V4 '21-

M O U N T I N G I N S T R U C T I O N S

REF 20728

CÚPULA TOURING / TOURING SCREEN

Typ: VS2



S22 38182*26

ID	PIEZA/PART	DESCRIPCIÓN	DESCRIPTION	QTY	REF
1		Cúpula Touring	Touring screen	1	20728H/WM3
2		Soporte izquierdo (L)	Left support (L)	1	SOPOR2P2-L20728
3		Soporte derecho (R)	Right support (R)	1	SOPOR2P2-R20728
4		Tornillo Allen M5x11 Ø11 ISO 7380	M5x11 Ø11 ISO 7380 Allen screw	4	TORNI-AI----520
5		Silentblock Ø9 xØ6 x8mm	Ø9 xØ6 x8mm silentblock	4	AROPASACABLES-3
6		Casquillo con valona Ø12xØ6,8x7,3	Ø12xØ6,8x7,3 bush with flange	4	CASQUI-1A---750
7		Tornillo Allen M5x16 Ø11 ISO 7380	M5x16 Ø11 ISO 7380 Allen screw	4	TORNI-I7380-493
8		Tapón tornillo M5 ISO 7380	M5 ISO 7380 screw cap	4	TAPON-----85

DUCATI MULTISTRADA V4 '21-

INSTRUCCIONES DE MONTAJE - MOUNTING INSTRUCTIONS - MONTAGEANLEITUNG

1

**DISASSEMBLY
DESMONTAJE**

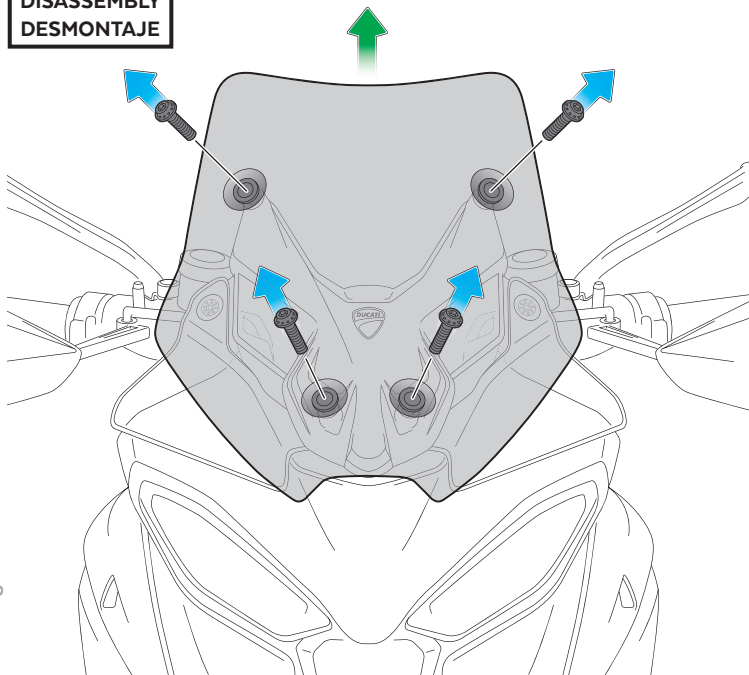

2

**ASSEMBLY
MONTAJE**

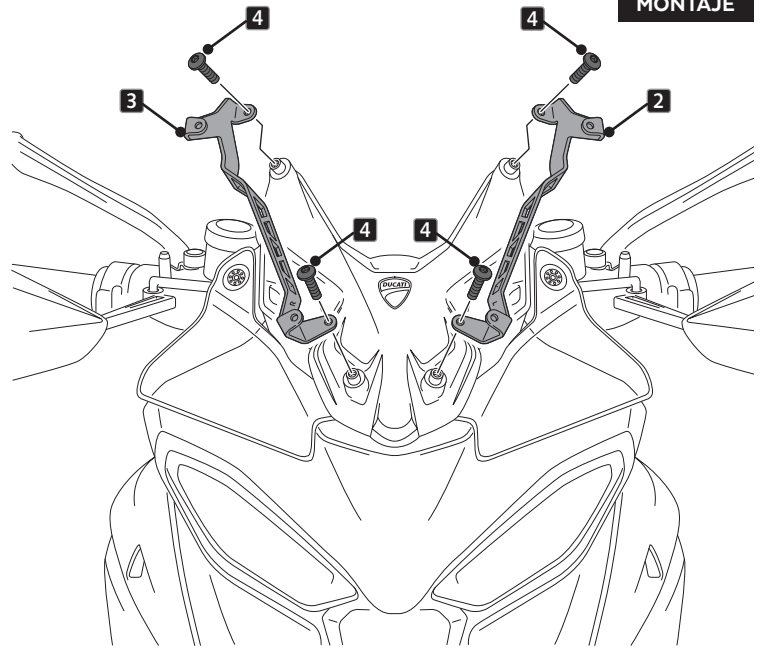

3

**ASSEMBLY
MONTAJE**

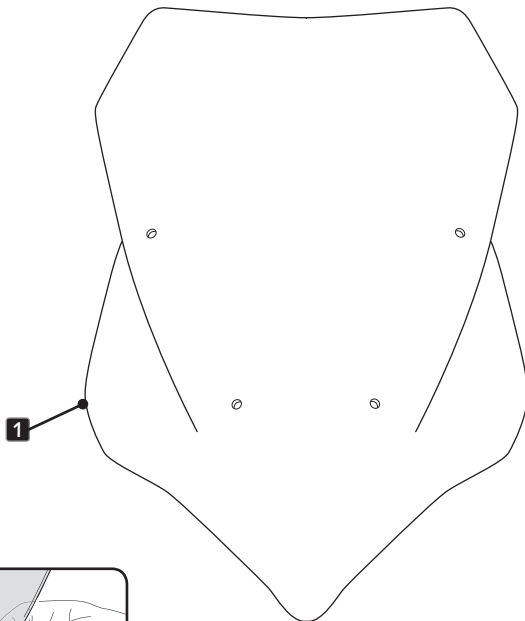

4

**ASSEMBLY
MONTAJE**

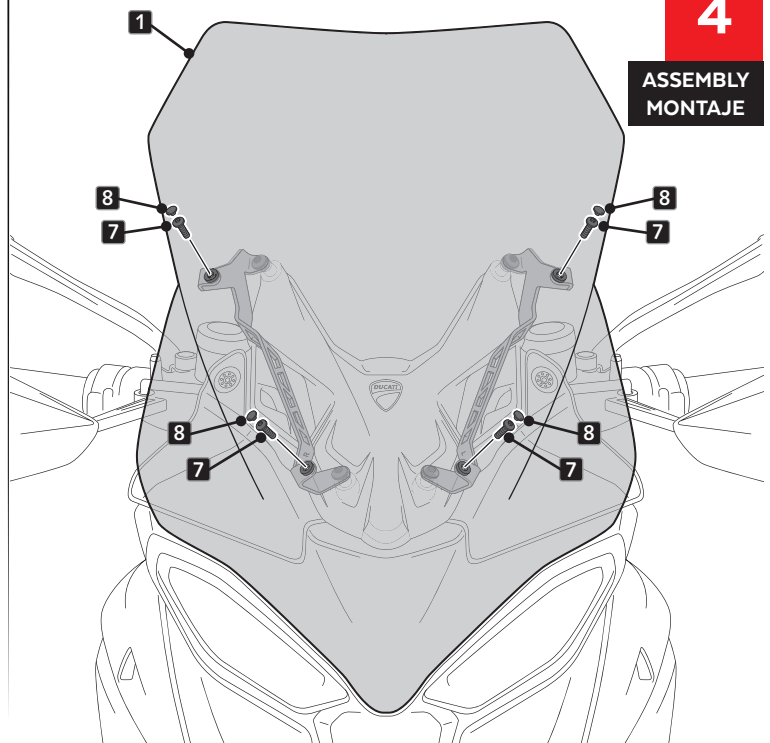

S22 38182*26

DUCATI MULTISTRADA V4 '21-

M O U N T I N G I N S T R U C T I O N S

REF 20729

CÚPULA SPORT / SPORTSCREEN



1 Person



15 min



EASY







Typ: VS3

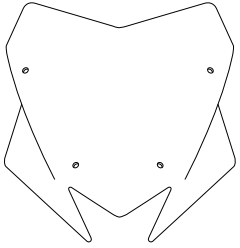
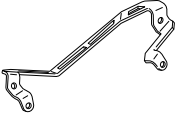
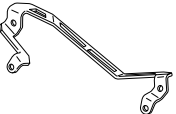

TORX
T25

ALLEN
Nº 3

S22 38182*26

ID	PIEZA/PART	DESCRIPCIÓN	DESCRIPTION	QTY	REF
1		Cúpula Sport	Sport screen	1	20729C/F/H/W/NM3
2		Soporte izquierdo (L)	Left support (L)	1	SOPOR2P4-L20729
3		Soporte derecho (R)	Right support (R)	1	SOPOR2P4-R20729
4		Tornillo Allen M5x11 Ø11 ISO 7380	M5x11 Ø11 ISO 7380 Allen screw	4	TORNI-AI----520
5		Silentblock Ø9 xØ6 x8mm	Ø9 xØ6 x8mm silentblock	4	AROPASACABLES-3
6		Casquillo con valona Ø12xØ6,8x7,3	Ø12xØ6,8x7,3 bush with flange	4	CASQUI-1A---750
7		Tornillo Allen M5x16 Ø11 ISO 7380	M5x16 Ø11 ISO 7380 Allen screw	4	TORNI-I7380-493
8		Tapón tornillo M5 ISO 7380	M5 ISO 7380 screw cap	4	TAPON-----85

DUCATI MULTISTRADA V4 '21-

INSTRUCCIONES DE MONTAJE - MOUNTING INSTRUCTIONS - MONTAGEANLEITUNG

1

**DISASSEMBLY
DESMONTAJE**

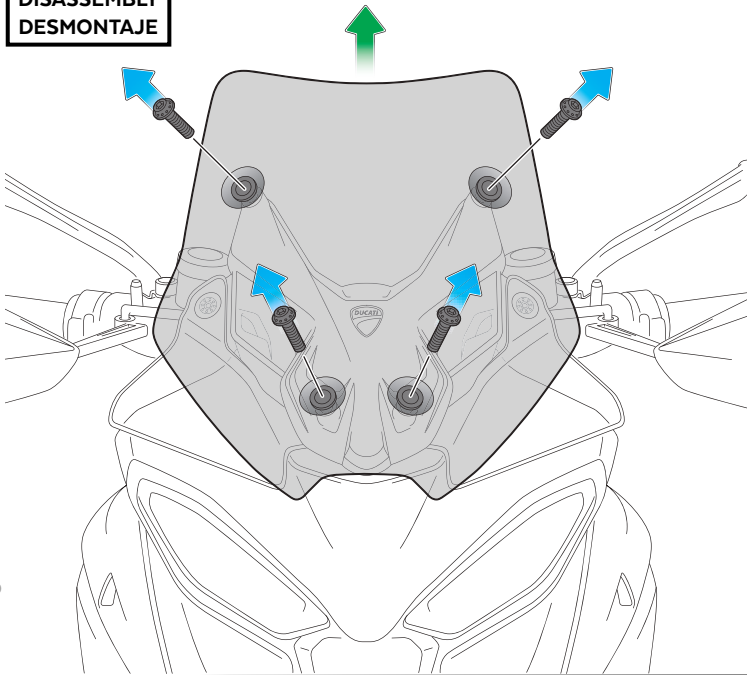

2

**ASSEMBLY
MONTAJE**

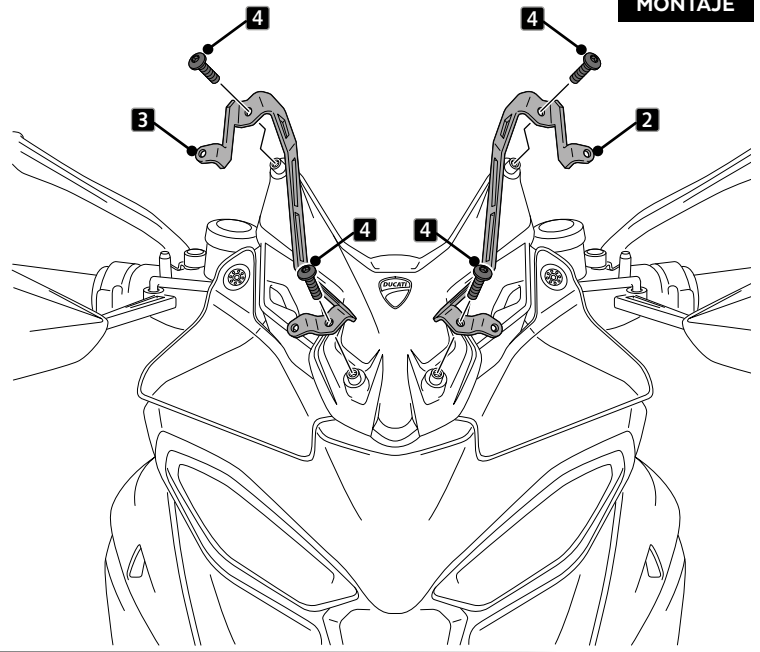

3

**ASSEMBLY
MONTAJE**

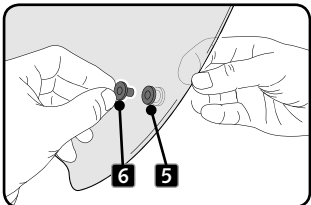
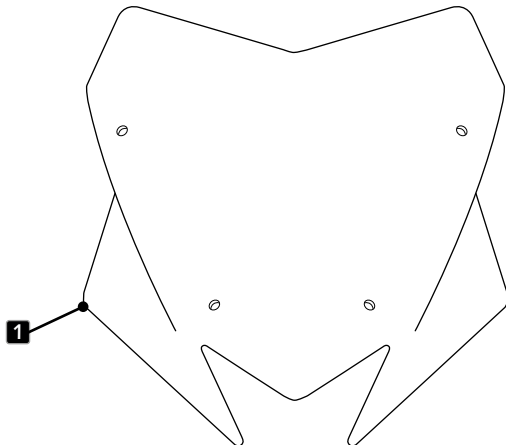

4

**ASSEMBLY
MONTAJE**

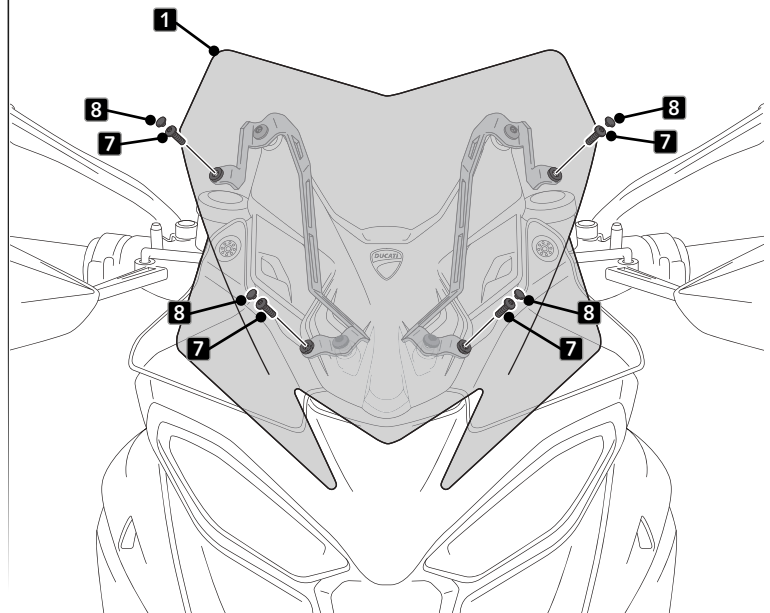

HONDA NC750X '21-

M O U N T I N G I N S T R U C T I O N S

REF 20752

TOURING SCREEN

Typ: VS2

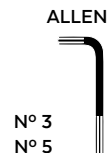

S22 38182*26

ID.	PIEZA/PART	DESCRIPCIÓN	DESCRIPTION	QTY.	REF.:
1		Cúpula TOURING	TOURING screen	1	20752F/H/W/NM3
2		Silentblock Ø9xØ6x8 mm	Ø9xØ6x8 mm silentblock	4	AROPASACABLES-3
3		Casquillo con valona Ø12xØ6x7,3	Ø12xØ6x7,3 bush with flange	4	CASQUI-1A---750
4		Tornillo allen M5x20 Ø11 ISO 7380	M5x20 Ø11 ISO 7380 allen screw	4	TORNI-I7380-730
5		Tapon tornillo M5 ISO 7380	M5 ISO 7380 screw cap	4	TAPON-----85

HONDA NC750X '21-

INSTRUCCIONES DE MONTAJE - MOUNTING INSTRUCTIONS - MONTAGEANLEITUNG

1

DISASSEMBLY
DESMONTAJE

A Tornillería original
Original screws

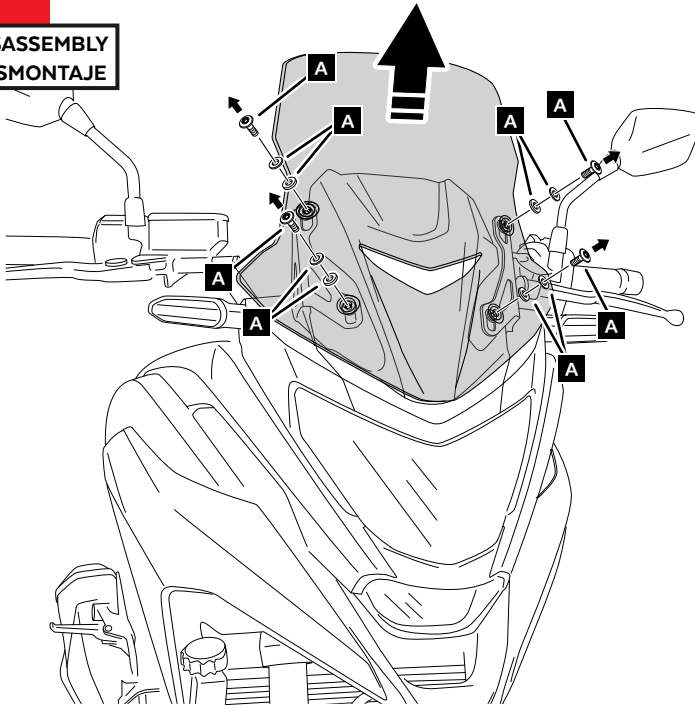

3

ASSEMBLY
MONTAJE

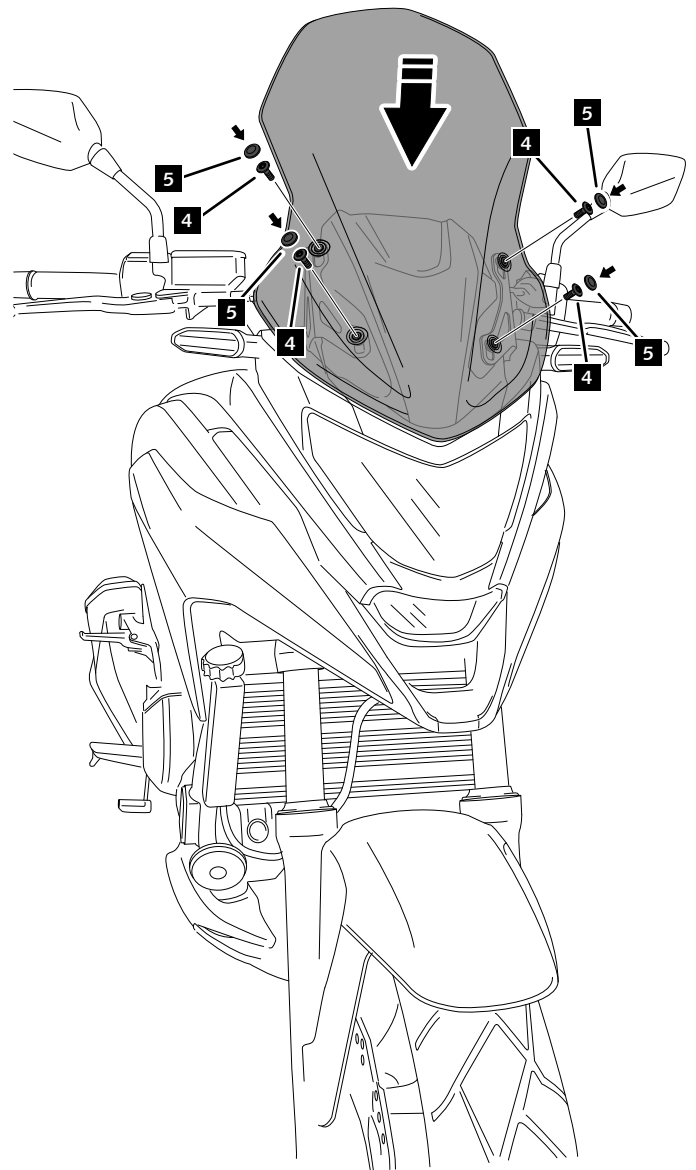

2

ASSEMBLY
MONTAJE

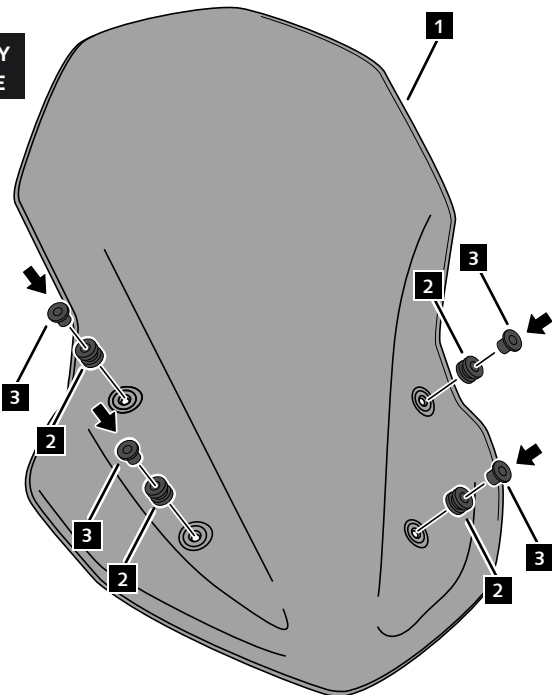

S22 38182*26

HONDA NC750X '21-

M O U N T I N G I N S T R U C T I O N S

REF 20773

SPORT SCREEN

Typ: VS3



1 Person



15 min



EASY



ALLEN



N° 3
N° 5

S22 38182*26

ID.	PIEZA/PART	DESCRIPCIÓN	DESCRIPTION	QTY.	REF.:
1		Cúpula sport	Sport screen	1	20773F/H/W/NM3
2		Silentblock Ø9xØ6x8 mm	Ø9xØ6x8 mm silentblock	4	AROPASACABLES-3
3		Casquillo con valona Ø12xØ6x7,3	Ø12xØ6x7,3 bush with flange	4	CASQUI-1A---750
4		Tornillo allen M5x20 Ø11 ISO 7380	M5x20 Ø11 ISO 7380 allen screw	4	TORNI-I7380-730
5		Tapon tornillo M5 ISO 7380	M5 ISO 7380 screw cap	4	TAPON-----85

* Algunos componentes se suministran montados.
Some components are supplied assembled.

VO.07/21

HONDA NC750X '21-

INSTRUCCIONES DE MONTAJE - MOUNTING INSTRUCTIONS - MONTAGEANLEITUNG

1

DISASSEMBLY
DESMONTAJE

A Tornillería original
Original screws

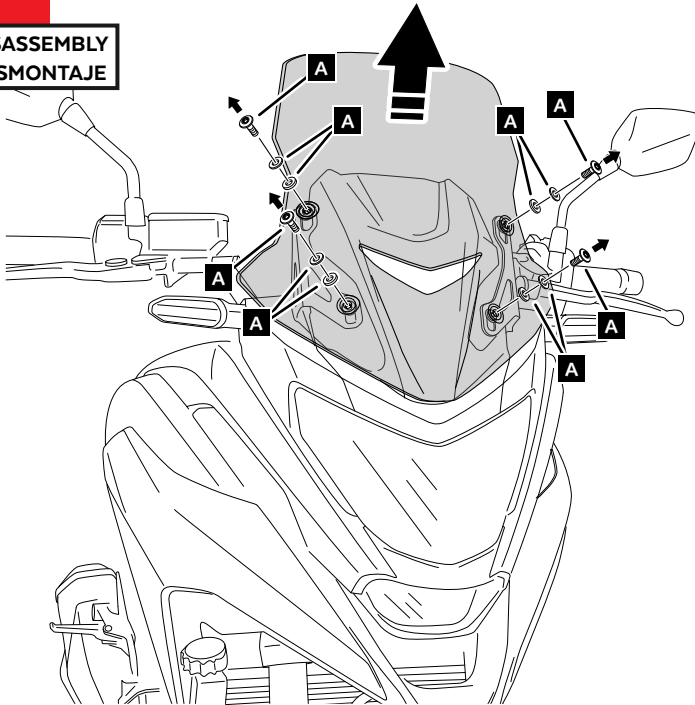

2

ASSEMBLY
MONTAJE

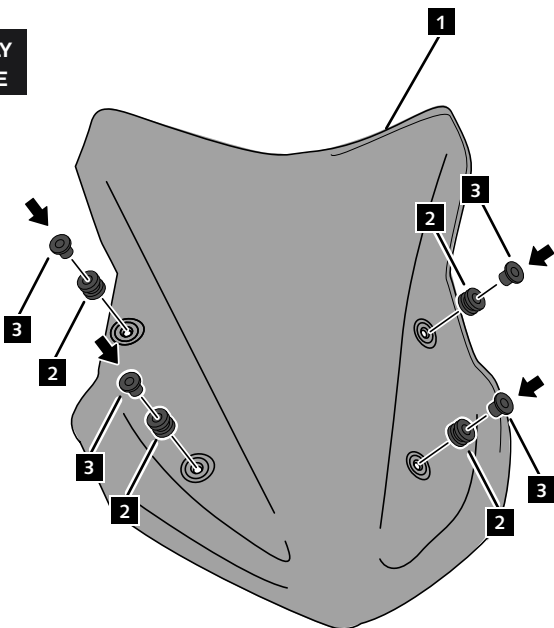

3

ASSEMBLY
MONTAJE

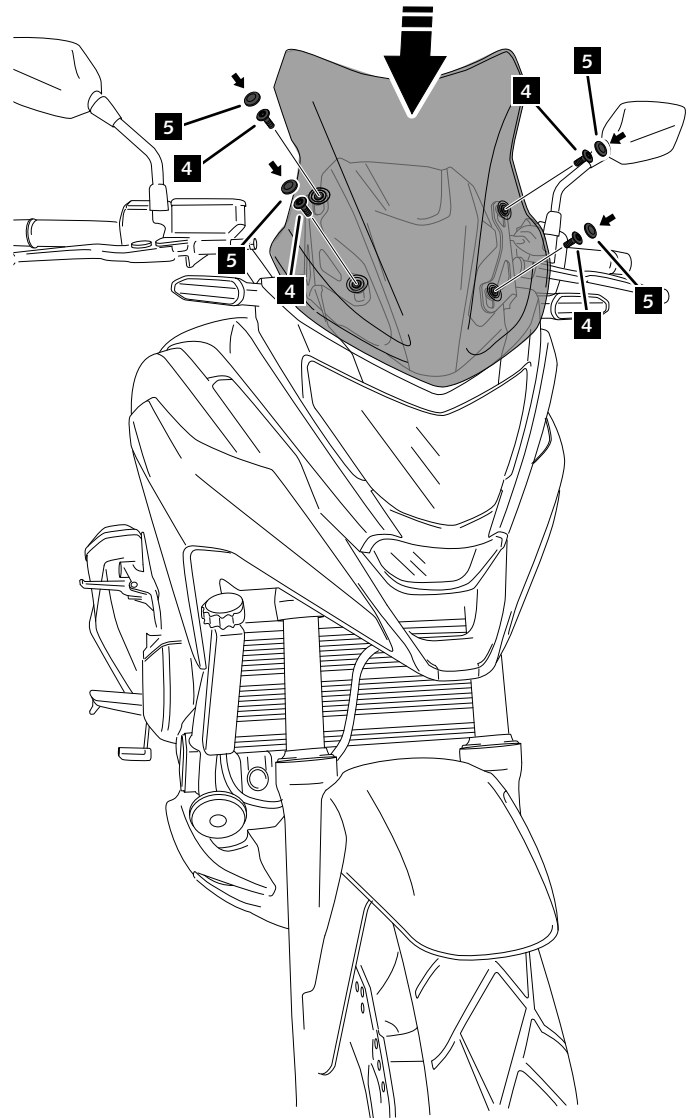

S22 38182*26

BMW R1250RT' 21-

M O U N T I N G I N S T R U C T I O N S

REF 20774

CÚPULA TOURING / TOURING SCREEN



1 Person



15 min



EASY



Typ: VS2

TORX
T30

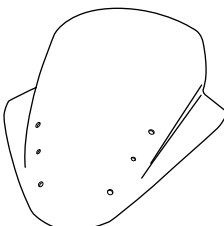

ID	PIEZA/PART	DESCRIPCIÓN	DESCRIPTION	QTY	REF
1		Cúpula Touring	Touring screen	1	20774F/H/WM3

* Algunos componentes se suministran montados.
Some components are supplied assembled.

S22 38182*26

BMW R1250RT' 21-

INSTRUCCIONES DE MONTAJE - MOUNTING INSTRUCTIONS - MONTAGEANLEITUNG

1

DISASSEMBLY
DESMONTAJE

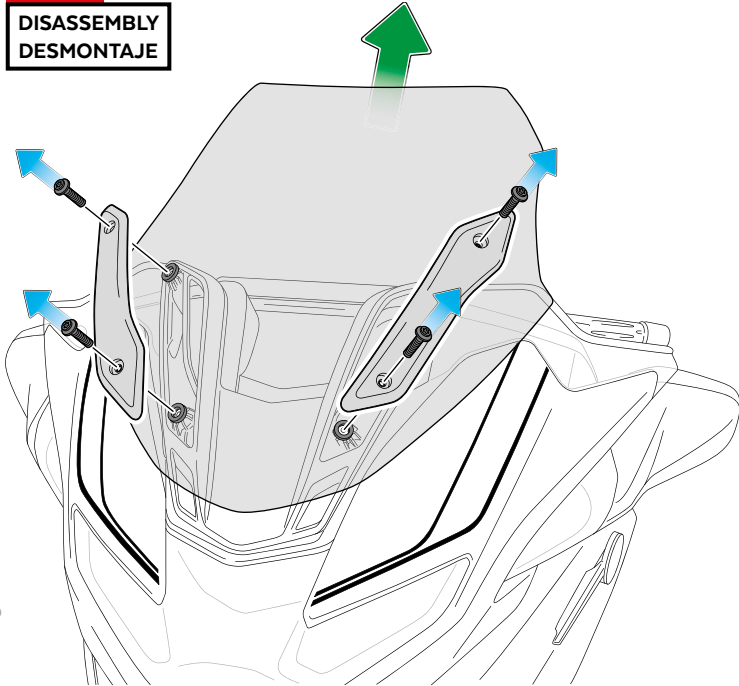

2

DISASSEMBLY
DESMONTAJE

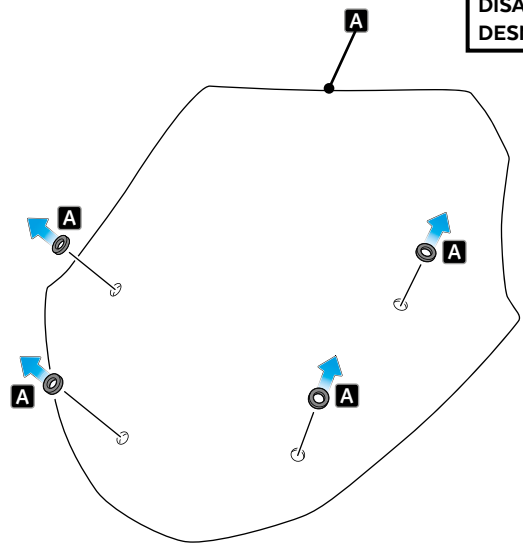

A PIEZA ORIGINAL
ORIGINAL PART

3

ASSEMBLY
MONTAJE

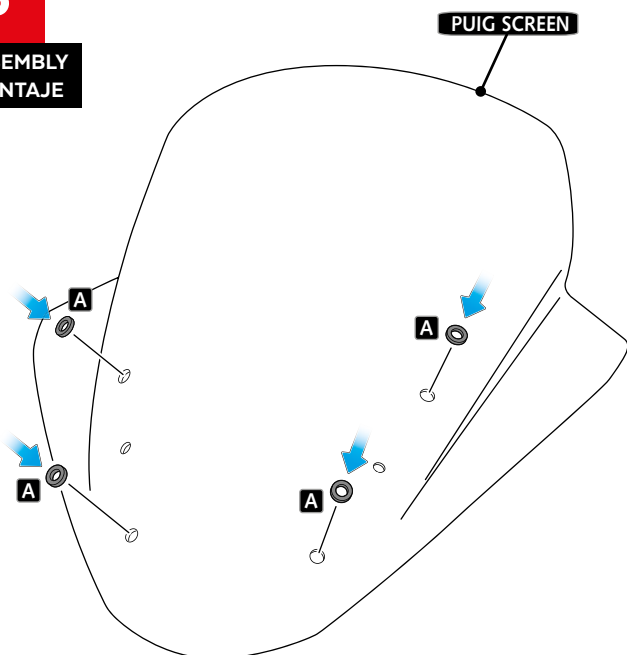

A PIEZA ORIGINAL
ORIGINAL PART

4

ASSEMBLY
MONTAJE

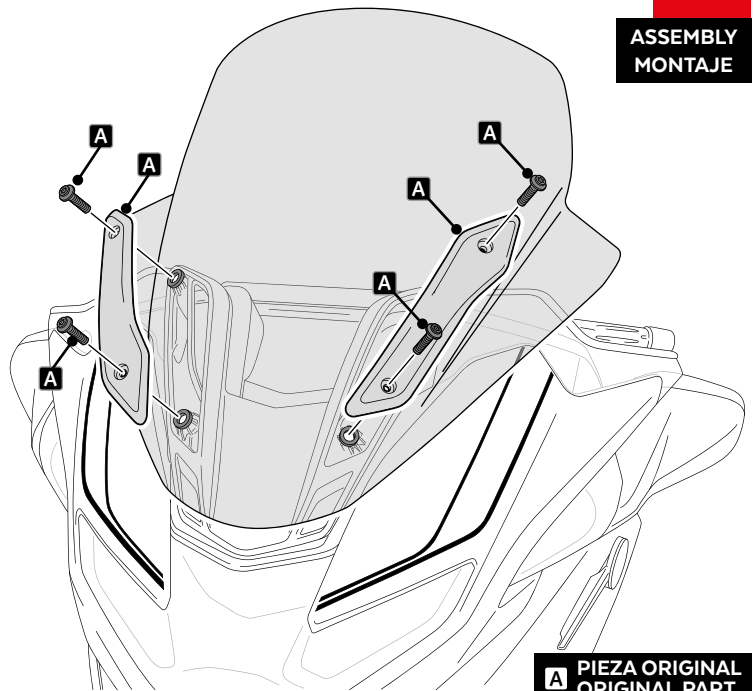

A PIEZA ORIGINAL
ORIGINAL PART

APRILIA TUONO 660 '21-

M O U N T I N G I N S T R U C T I O N S

REF 20794

Z-RACING SCREEN

Typ: VS3



1 Person



20 min



EASY









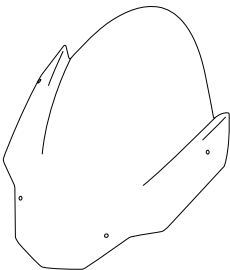

ALLEN

Nº 2,5
Nº 3



S22 38182*26

ID	PIEZA/PART	DESCRIPCIÓN	DESCRIPTION	QTY	REF
1		Cúpula Z-RACING	Z-RACING screen	1	20794H/W/N/FM3
2		Soporte izquierdo (L)	Left support (L)	1	SOPOR3P4-L20794
3		Soporte derecho (R)	Right support (R)	1	SOPOR3P4-R20794
4		Soporte central	Central support	1	SOPOR3P4--20794
5		Tornillo Allen M4x16 ISO 7380	M4x16 ISO 7380 Allen screw	4	TORNIAI7380-310
6		Silentblock M5	M5 silentblock	4	SILENBTM5-046/1
7		Tornillo Allen M5x16 Ø11 ISO 7380	M5x16 Ø11 ISO 7380 Allen screw	4	TORNI-I7380-493
8		Arandela M5 nylon	M5 nylon washer	4	ARNV0000000245
9		Tapón tornillo M5 ISO 7380	M5 ISO 7380 screw cap	4	TAPON-----85

* Algunos componentes se suministran montados.
Some components are supplied assembled.

APRILIA TUONO 660 '21-

INSTRUCCIONES DE MONTAJE - MOUNTING INSTRUCTIONS - MONTAGEANLEITUNG

1

DISASSEMBLY
DESMONTAJE

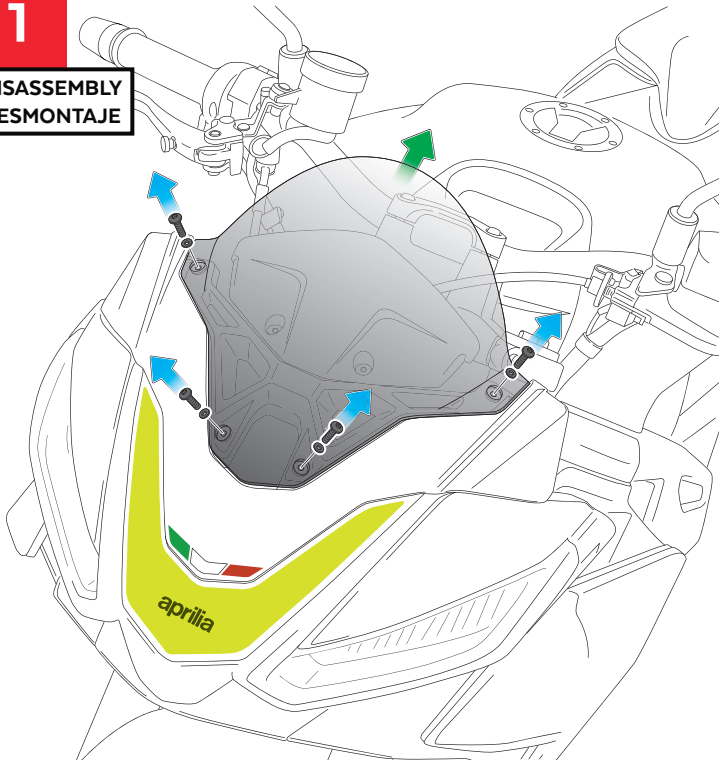

2

ASSEMBLY
MONTAJE

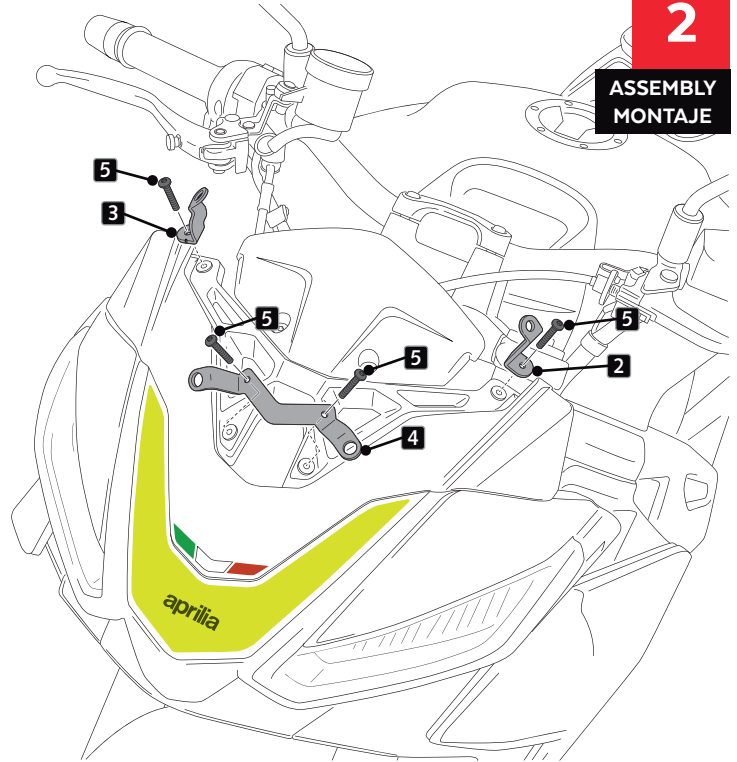

3

ASSEMBLY
MONTAJE

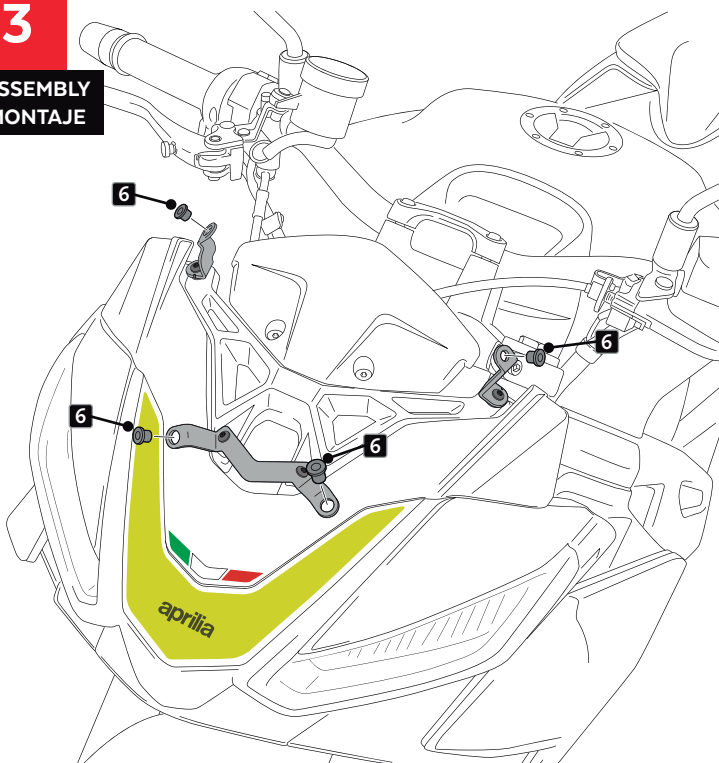

4

ASSEMBLY
MONTAJE

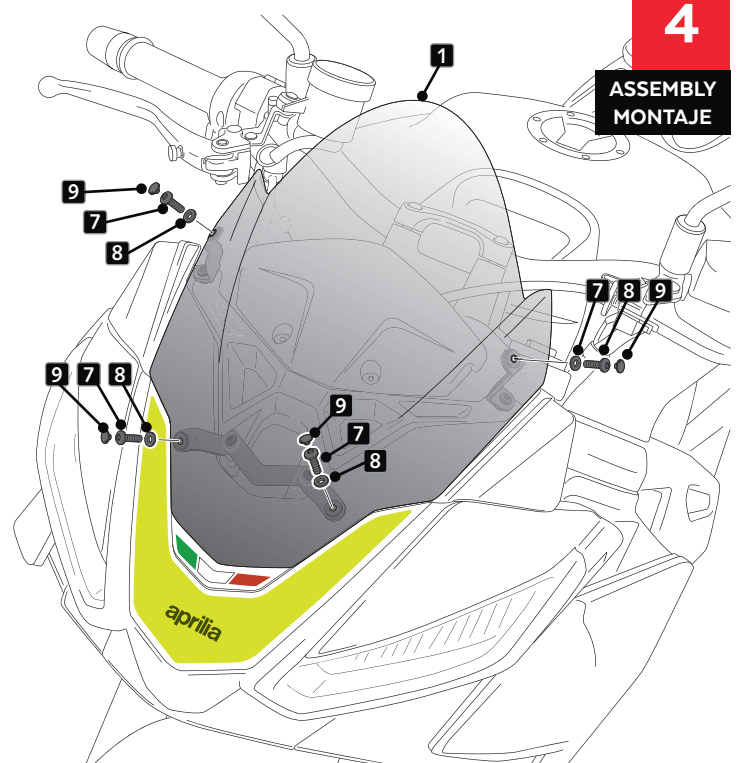

S22 38182*26

KTM 1290 SUPERADVENTURE R/S '21-

M O U N T I N G I N S T R U C T I O N S





REF 20816

TOURING PLUS SCREEN

Typ: VS2



S22 38182*26

ID.	PIEZA/PART	DESCRIPCIÓN	DESCRIPTION	QTY.	REF.:
1		Cúpula TOURING PLUS	TOURING PLUS screen	1	20816W/H/FM3
2		Tornillo especial M5x8 Long Hexagonal 25 (Rosca int M5x20)	M5x8 special screw hexagonal Lenght 25	2	TORNI-EM5---732
3		Tornillo especial M5x8 Long Hexagonal 14 (Rosca int M5x13)	M5x8 special screw hexagonal Lenght 14	2	TORNI-EC----597
4		Silentblock Ø9 xØ6 x8mm	Ø12xØ6x9 Silentblock	4	AROPASACABLES-3
5		Casquillo con valona Ø12xØ6,8x7,3	Ø12xØ6,8x7,3 bush with flange	4	CASQUI-1A---750
6		Tornillo allen M5x16 Ø11 ISO 7380	M5x16 Ø11 ISO 7380 allen Screw	4	TORNI-I7380-493
7		Tapón tornillo M5 ISO 7380	M5 ISO7380 screw cap	4	TAPON-----85

* Algunos de los Componentes se suministran montados
Some components are supplied assembled

KTM 1290 SUPERADVENTURE R/S '21-

INSTRUCCIONES DE MONTAJE - MOUNTING INSTRUCTIONS - MONTAGEANLEITUNG

1

**DISASSEMBLY
DESMONTAJE**

A Tornillería original
Original screws

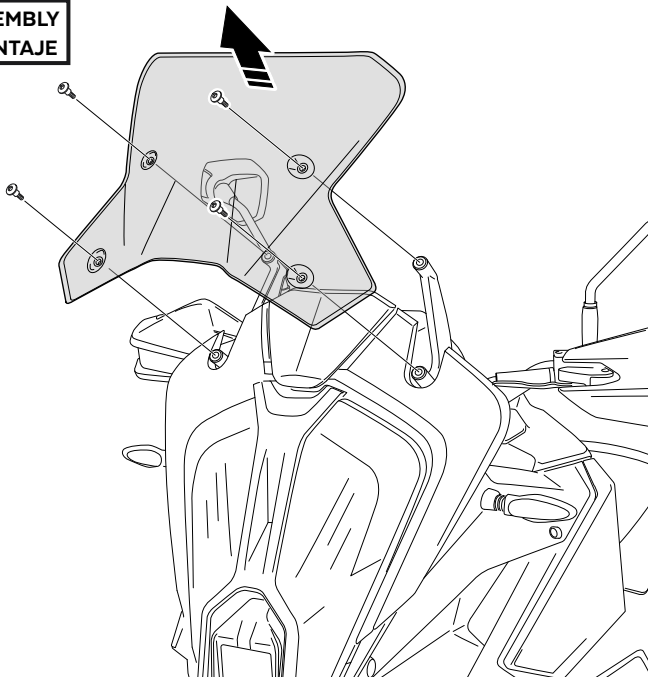

3

**ASSEMBLY
MONTAJE**

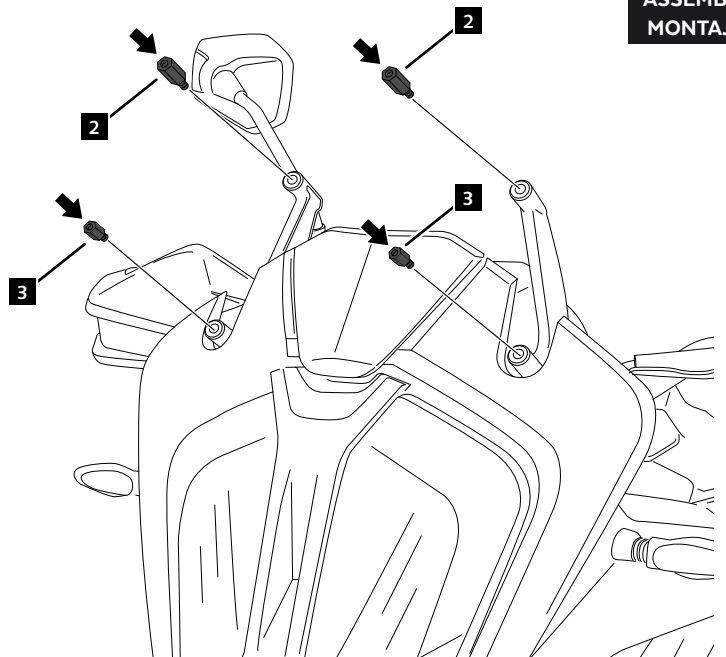

2

**ASSEMBLY
MONTAJE**

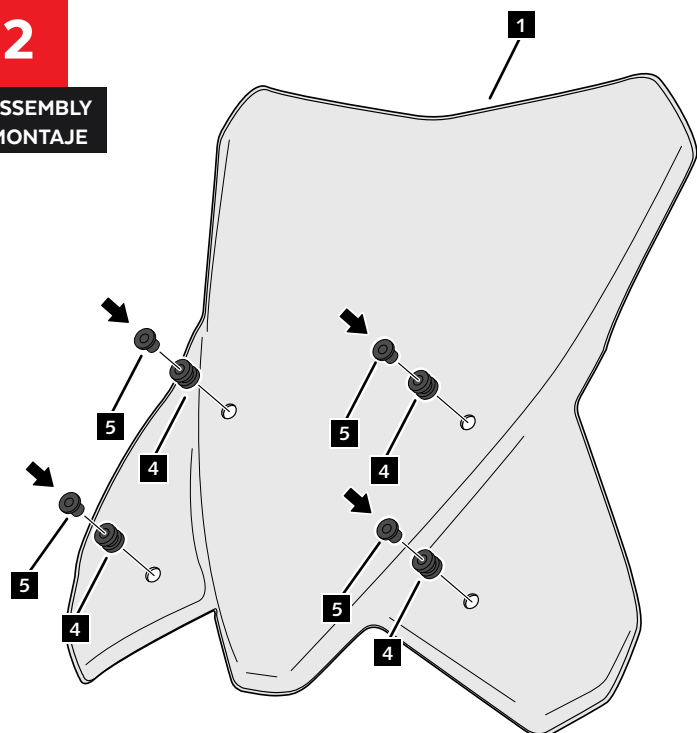

4

**ASSEMBLY
MONTAJE**

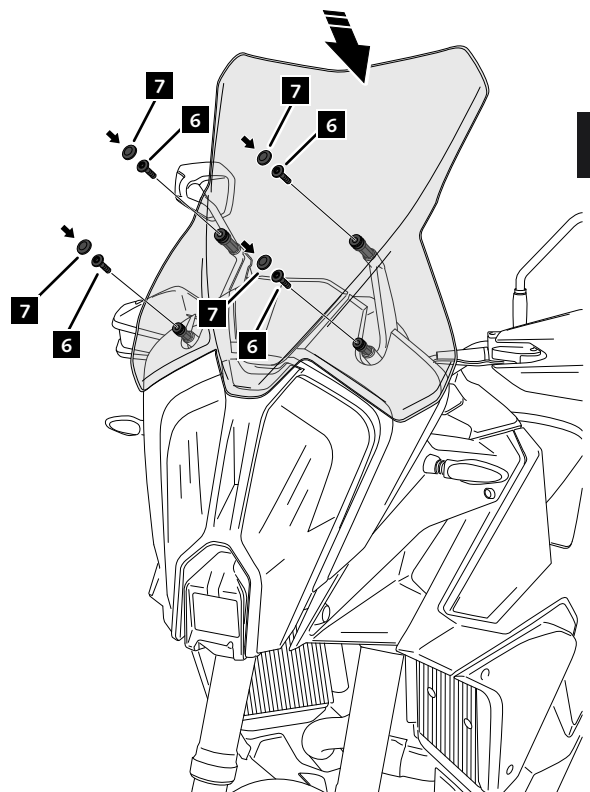

S22 38182*26

2.0 MULTI-ADJUSTABLE VISOR (FIX)

M O U N T I N G I N S T R U C T I O N S

REF 20763

UNIVERSAL (FIXED VERSION)



1 Person



15 min



EASY

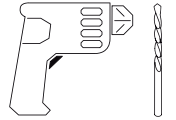

Ø7



PHILLIPS
SCREWDRIVER



ALLEN
Nº 4

ID	PIEZA/PART	DESCRIPCIÓN	DESCRIPTION	QTY	REF
1		Visera de policarbonato antirayadas	Antiscratch polycarbonate Visor	1	20765H/WM3
2		Plantilla	Template	1	PLANTILLA-VISOR
3		Mecanismo Izquierdo	Left Mechanism	1	See exploding page 2
4		Mecanismo Derecho	Right Mechanism	1	See exploding page 2

2.0 MULTI-ADJUSTABLE VISOR (FIX)

INSTRUCCIONES DE MONTAJE - MOUNTING INSTRUCTIONS - MONTAGEANLEITUNG

1

EXPLOTING

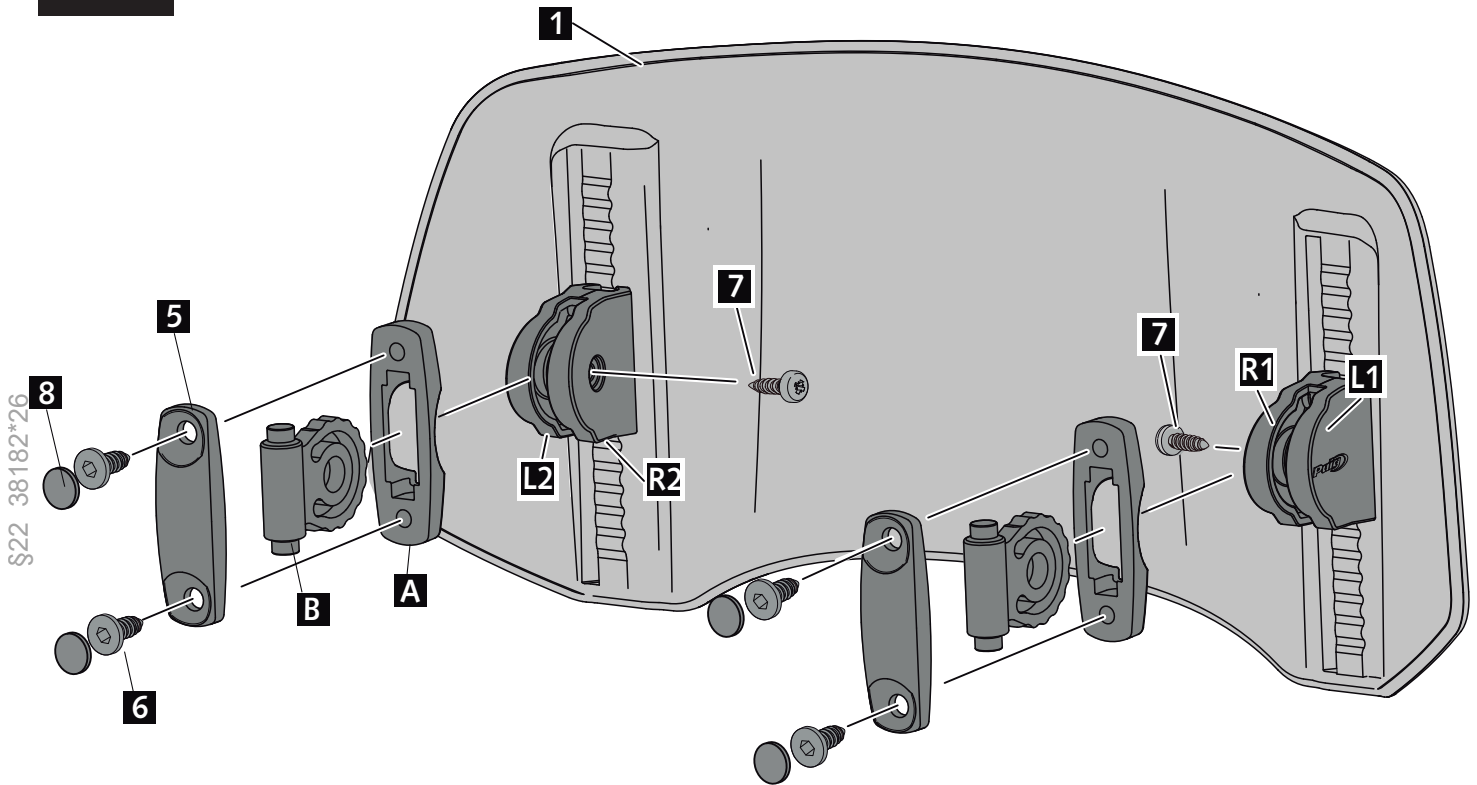

S22 38182*26

ID	PIEZA/PART	DESCRIPCIÓN	DESCRIPTION	QTY	REF
A		Tapa pieza eje	Axle part cover	2	TAPAEJE-VISOR--
B		Pieza eje	Axle part	2	EJE-FIX-VISOR--
L2		Tapa 2 Logo	Logo cover 2	1	TAPALAT-VISORL2
R2		Tapa 2 Tornillo	Screw cover 2	1	TAPALAT-VISORR2
L1		Tapa 1 Logo	Logo cover 1	1	TAPALAT-VISORL1
R1		Tapa 1 Tornillo	Screw cover 1	1	TAPALAT-VISORR1
5		Tapa cúpula	screen cover	2	TAPAFIX-VISOR--
6		Tornillo allen S.T. 6,3 x14	S.T. 6,3 x14 Allen screw	4	TOZN00M60000258
7		Tornillo Ø3,5x9,5 DIN7981 F	Ø3,5x9.5 DIN7981F screw	2	TORNI-D7981-885
8		Tapón tornillo M6	M6 Screw cap	4	TAPON-----81

2.0 MULTI-ADJUSTABLE VISOR (FIX)

INSTRUCCIONES DE MONTAJE - MOUNTING INSTRUCTIONS - MONTAGEANLEITUNG

2

ASSEMBLY
MONTAJE

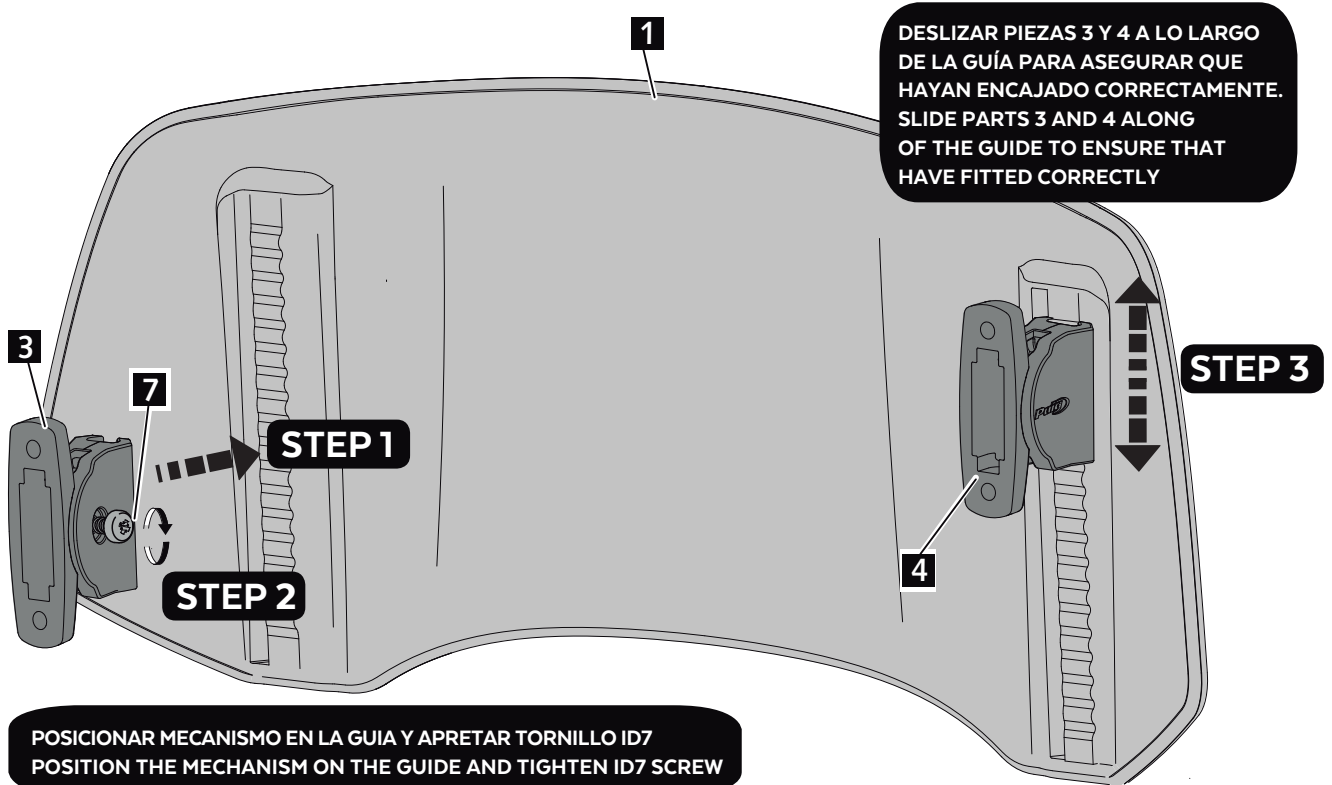

PAR APRIETE TORNILLO ID7 1,4 Nm
TIGHTENING TORQUE FOR ID7 SCREWS 1,4 Nm

S22 38182*26

2.0 MULTI-ADJUSTABLE VISOR (FIX)

INSTRUCCIONES DE MONTAJE - MOUNTING INSTRUCTIONS - MONTAGEANLEITUNG

3

SCREEN TYPE “ ——— ”

ASSEMBLY
MONTAJE

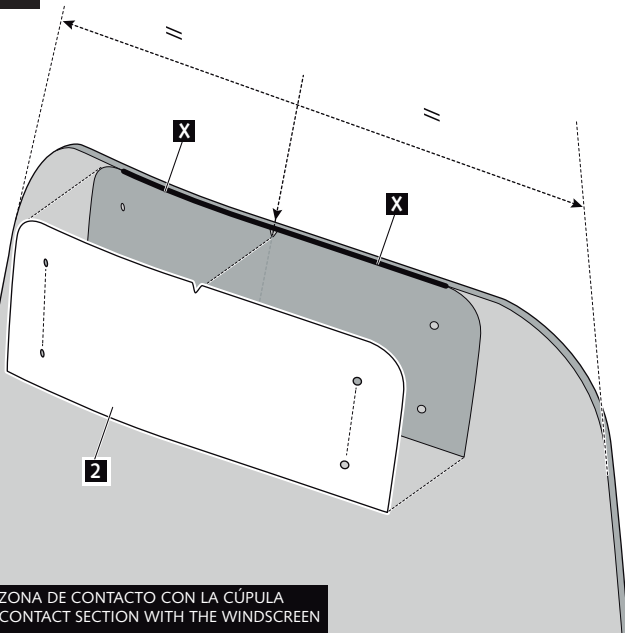

X ZONA DE CONTACTO CON LA CÚPULA
CONTACT SECTION WITH THE WINDSCREEN

SCREEN TYPE “ ——— ”

3

ASSEMBLY
MONTAJE

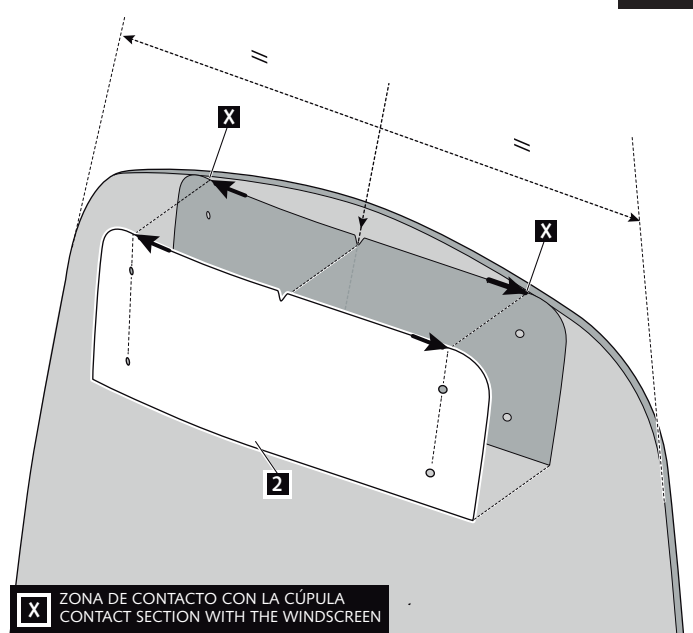

X ZONA DE CONTACTO CON LA CÚPULA
CONTACT SECTION WITH THE WINDSCREEN

3

SCREEN TYPE “ ——— ”

ASSEMBLY
MONTAJE

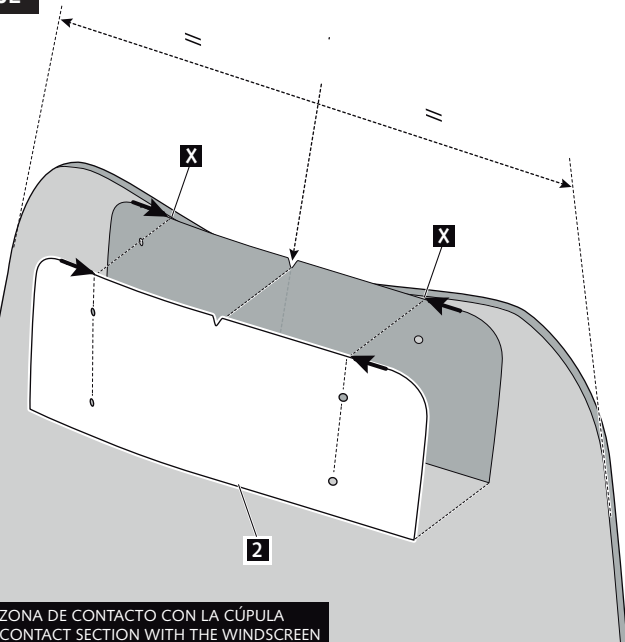

X ZONA DE CONTACTO CON LA CÚPULA
CONTACT SECTION WITH THE WINDSCREEN

4

ASSEMBLY
MONTAJE

⚠ UTILIZAR UN TACO DE MADERA EN LA POSTERIOR
USE A WOOD BLOCK ON THE OTHER SIDE

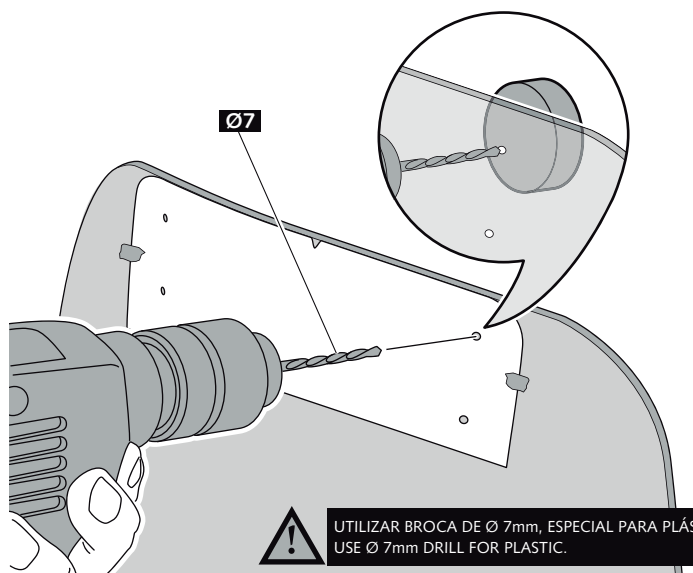

⚠ UTILIZAR BROCA DE Ø 7mm, ESPECIAL PARA PLÁSTICO.
USE Ø 7mm DRILL FOR PLASTIC.

S22 38182*26

2.0 MULTI-ADJUSTABLE VISOR (FIX)

INSTRUCCIONES DE MONTAJE - MOUNTING INSTRUCTIONS - MONTAGEANLEITUNG

5

ASSEMBLY
MONTAJE

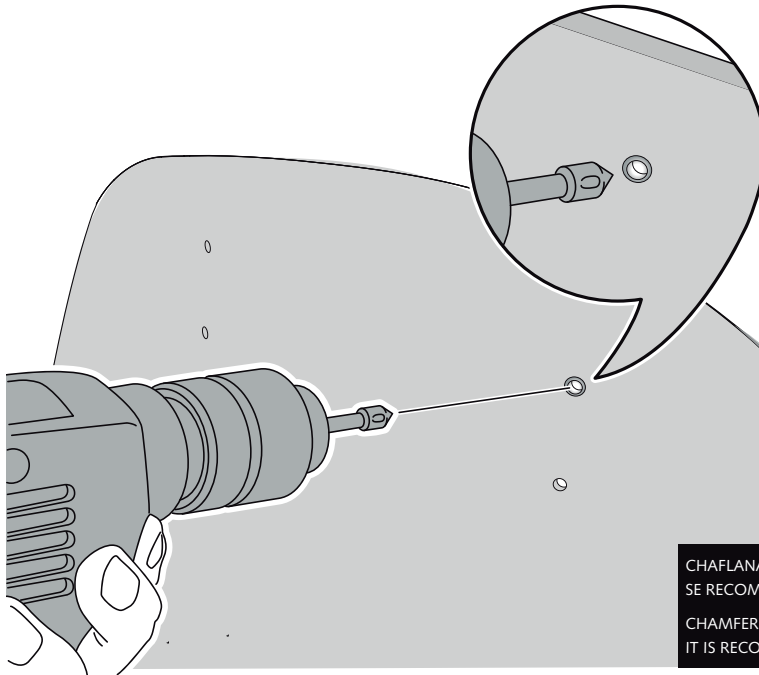

CHAFLANAR LOS 4 AGUJEROS POR AMBOS LADOS.
SE RECOMIENDA REALIZAR CHAFLAN $\varnothing 10\text{mm} - \varnothing 20\text{mm}$
CHAMFER THE FOUR HOLES ON BOTH SIDES.
IT IS RECOMMENDED TO MAKE CHAMFER $\varnothing 10\text{mm} - \varnothing 20\text{mm}$

6

ASSEMBLY
MONTAJE

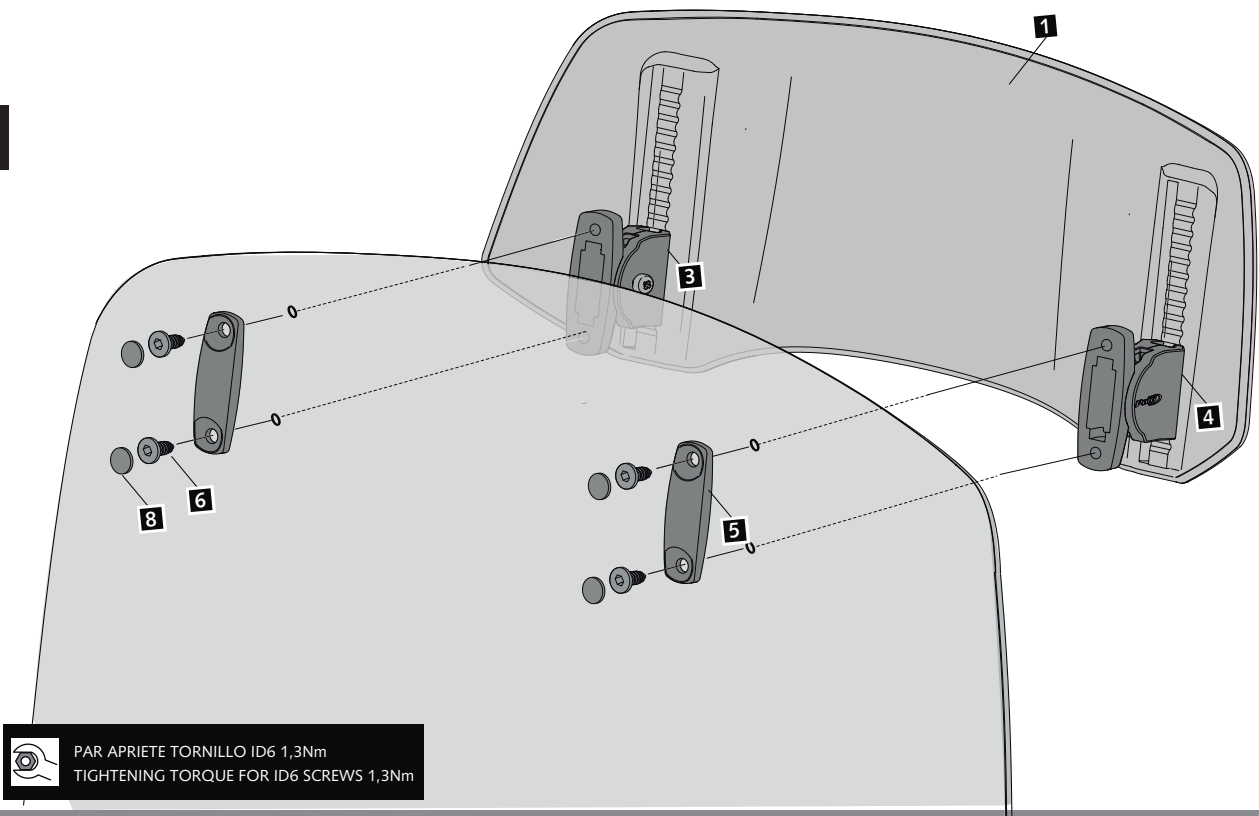

PAR APRIETE TORNILLO ID6 1,3Nm
TIGHTENING TORQUE FOR ID6 SCREWS 1,3Nm